

The Combination of Hydrogen and Chlorine under the Influence of Light

P. V. Bevan

Phil. Trans. R. Soc. Lond. A 1904 **202**, 71-121

doi: 10.1098/rsta.1904.0002

Email alerting service

Receive free email alerts when new articles cite this article - sign up in the box at the top right-hand corner of the article or click [here](#)

II. *The Combination of Hydrogen and Chlorine under the Influence of Light.*

By P. V. BEVAN, M.A., *Fellow of Trinity College, Cambridge.*

Communicated by Professor J. J. THOMSON, F.R.S.

Received April 1,—Read May 14, 1903.

CONTENTS.

	Page
I. Historical introduction	71
II. Experimental investigation	78
1. The initial expansion	82
§ 1. The relation of the initial expansion to the time of insolation	83
§ 2. The relation to the hydrochloric acid formed	86
§ 3. The temperature change associated with the initial expansion	88
§ 4. Conclusions	89
§ 5. The expansion of chlorine alone under the influence of light	90
2. The final contraction	91
3. The period of induction	94
§ 1. Prolongation of the period of induction	94
§ 2. The effect after darkening	95
§ 3. The effect of impurities	98
§ 4. The effect of previous insolation of the separate gases	101
§ 5. Expansion experiments	103
§ 6. Experiments with dried gases, and other experiments	108
III. Theory of the action	109
Summary	120

I. HISTORICAL INTRODUCTION.*

IN the year 1801, WILLIAM CRUICKSHANK† noticed the gradual combination of a mixture of hydrogen and chlorine in diffuse daylight. GAY LUSSAC and THENARD‡ observed that the mixture of these two gases exploded on exposure to direct sunlight.

* For the historical introduction I am much indebted to a paper by MELLOR in the 'Journal of the Chemical Society,' vol. 79, 1901.

† CRUICKSHANK, 'Nicholson's Journal,' 1801.

‡ GAY LUSSAC and THENARD, 'Mem. Soc. Phys. d'Arcueil,' 1809.

In the same year, 1809, DALTON* made several experiments with direct sunlight, and with diffuse daylight, as causes of the combination. He states, "upon repeating the experiment with sundry variations it was confirmed that light is the cause of this rapid combustion of hydrogen and oxymuriatic gas; that the more powerful is the light, the more rapid is the diminution of the mixture; and that if the eudiometer be covered by an opaque body, the mixture will scarcely be affected with any diminution for a day, and will not completely disappear in two or three weeks. Moreover when the diminution is going on with speed, if the hand, or any other opaque body, is interposed to cut off the solar light, the diminution is instantly suspended." DALTON also, as well as CRUICKSHANK, noticed that the diminution did not begin at once under the influence of sunlight. This was the first notice of the "period of induction" of BUNSEN and ROSCOE. DALTON, in his analysis of the oxymuriatic gas, mixes hydrogen and chlorine in an eudiometer over mercury and water, and exposes the mixture to the sunlight, "when after remaining two or three minutes without any change, the water, and afterwards the mercury ascend the tube with increasing and afterwards diminishing velocity, till they nearly reach the top." SEEBECK discovered the effect of difference in the colour of the light used, observing that in a clear glass vessel explosion occurred with sunlight, in a dark blue vessel combination occurred quickly without explosion, whilst in a dark red glass vessel the action was very slow.

DRAPER took up the investigation in 1840 and made a series of careful and detailed experiments resulting in the invention of the "tithonometer," an instrument by which he endeavoured to refer the chemical action of light to a standard measure. His first paper† contains a description of this instrument. In 1844 he published a memoir on "tithonised" chlorine, in which he gives some of his reasons for believing that the effect of light is to produce an allotropic form of chlorine. This view is further dealt with in a paper published in 1845. The allotropic modification is, according to DRAPER, more active than chlorine which has not been illuminated, as it combines readily with hydrogen even in the dark.‡ This conclusion was contradicted by BUNSEN and ROSCOE,§ who exposed the gases evolved by the electrolysis of hydrochloric acid separately to sunlight, and led them then into their "insolation" vessel. On exposing the mixture to light, they found no greater difference between the duration of the induction period of this pre-illuminated mixture and that of gases which had not been previously illuminated than is to be accounted for by unavoidable errors of experiment.|| This contradiction is explained by the fact that, in DRAPER'S experiment, the gases were mixed in the vessel where they were submitted to the

* DALTON, 'A New System of Chemical Philosophy,' I., p. 300.

† 'Phil. Mag.,' vol. 23, 1843.

‡ 'Phil. Mag.,' vol. 27, 1849, p. 339.

§ 'Phil. Trans.,' 1857, p. 382.

|| 'Phil. Trans.,' 1857, p. 398.

action of the light, while in BUNSEN and ROSCOE'S experiments the gases were bubbled through water into the "insolation" vessel after the preliminary exposure to light. (See later, p. 101).

FREMY and BECQUEREL* confirmed DRAPER'S result, finding that the effect of light on a damp mixture of hydrogen and chlorine is much greater if the chlorine has been previously illuminated than otherwise.

DRAPER† further discovered that if an intense light, such as that of a spark from a Leyden jar, be flashed on the mixture, a rapid expansion takes place, followed by a return to, or near to, the original volume. This expansion was also noticed and studied by PRINGSHEIM‡. Curiously enough, no mention of this effect is made by BUNSEN and ROSCOE.

BUNSEN and ROSCOE'S classical work on this action, as a means of measuring the chemical effect of light, appeared in 1855 and after. They investigated the phenomena from the beginning of illumination to the stage when the velocity of the action is constant. This interval of time they called the "Period of Induction." At the beginning of this period they observed the "period of inertness" noticed by CRUICKSHANK and DRAPER, after this inert period a period of acceleration, and finally a time when the velocity reached a constant maximum. On stopping the illumination they noticed also a further set of phenomena: a period of retardation followed by the complete cessation of the action. BUNSEN and ROSCOE introduced the words "insolation" and "insolated," the gas mixture being insolated when it has been exposed to light, and the gas being in a state of insolation as long as the effect of illumination persists.

The most important work after that of BUNSEN and ROSCOE is that of PRINGSHEIM.§ The subject of PRINGSHEIM'S investigation was the expansion noted by DRAPER at the moment of illumination with a bright light. He considered the effect of the heat liberated in the formation of hydrochloric acid molecules. From the known heat of formation of hydrochloric acid we should expect that if hydrochloric acid is formed immediately on the incidence of light, an expansion of 10·5 times the volume of hydrochloric acid formed would occur. The expansion, therefore, should be proportional to the hydrochloric acid formed. PRINGSHEIM concluded that this was not the case. With an instantaneous illumination, obtained by means of a spark, he observed a very small expansion followed by a return to the original volume; but no decrease of volume afterwards, showing the formation and absorption of hydrochloric acid. He concluded, therefore, that the heat liberated by the action is not the cause of the expansion.

PRINGSHEIM supposed that the first action of the light is to cause a dissociation of

* FREMY and BECQUEREL, 'WURTZ., Dict. de Chimie.,' 1879, II., p. 255.

† 'Phil. Mag.,' vol. 23, 1843, p. 415.

‡ PRINGSHEIM, 'Wied. Ann.,' 1887, vol. 32, p. 384.

§ 'Wied. Ann.,' 1887, vol. 32.

H_2 and Cl_2 molecules into atoms, which, giving rise to a larger number of systems in the gas mixture, causes an expansion. But the immediate effect of such a dissociation would not be to increase the volume at constant pressure. For the volume at constant pressure is proportional to the sum of the kinetic energies of all the molecules; and by a mere dissociation this total kinetic energy cannot be increased, so that the volume would at any rate not increase. In fact, we have

$$pv = \frac{1}{3}\Sigma mnC^2,$$

where n is the number of molecules per unit volume of molecular weight m , and C is their mean velocity. Then, in dissociation, Σmn is unaltered, and in the most favourable case, where no energy is needed for the dissociation, C is unaltered. But now the total number of molecular systems is increased and the average kinetic energy of the molecules is diminished, as in place of certain molecules m with velocity C we have molecules $\frac{1}{2}m$ with velocity C . The effect of this diminution of average kinetic energy is a fall in temperature. We have yet to consider whether energy is obtained from the light. BUNSEN and ROSCOE* have shown that the photochemical extinction—the light absorbed associated with the chemical action—is very considerably less than the optical extinction due to chlorine alone, and the amount of energy absorbed by chlorine alone from light is exceedingly small and not capable of producing an expansion at all comparable with that occurring with the mixture of gases. (See PRINGSHEIM, *loc. cit.*, p. 413, and below, p. 90.) The energy absorbed from the light is thus very much too small in quantity to have any appreciable effect in the initial expansion. The effect of dissociation would, therefore, be a fall in temperature of the mixture; and an expansion would only follow owing to heat being supplied from the walls of the containing vessel. Experiments described below (p. 88), however, show that associated with the expansion there is a rise in temperature; and that for very short illuminations, where there is not time for equalization of temperature between the gas and the vessel containing it, the rise in temperature is proportional to the amount of hydrochloric acid formed; and in all cases the expansion is fully accounted for by the rise in temperature observed. Under favourable conditions the ratio of expansion to the subsequent contraction, measuring the amount of hydrochloric acid formed, may be as much as 7 or 8, so that in PRINGSHEIM'S experiments, where the expansions were 2 millims. on his scale, the hydrochloric acid formed may have escaped detection. PRINGSHEIM† further concluded that the expansion due to a given quantity of light was independent of the amount of hydrochloric acid formed—independent of the state of the induction. This conclusion, however, is not borne out by more careful experiments—in fact, a corresponding phenomenon to the period of induction appears in the case of the initial expansion (see below, p. 83).

* 'Phil. Trans.,' "Photochemical Researches," Part III.

† PRINGSHEIM, *loc. cit.*, p. 413.

In 1897 GAUTIER and HÉLIER* investigated the action of light on dry chlorine and hydrogen. They noticed that the gas they prepared, by electrolysis of aqueous hydrochloric acid, did not consist of a mixture of the pure gases, but that there was present in addition oxygen, free, and combined with chlorine. This has also been shown by several observers; but the proof of the presence of oxygen when aqueous acid saturated with hydrochloric acid gas is used is not complete. MELLOR† concluded that the lower chlorine oxides formed in the process of electrolysis are all removed by washing, but that some free oxygen remains in the gas mixture. It remains, however, somewhat doubtful whether the oxygen found by MELLOR was not produced by decomposition of water vapour by chlorine, under the influence of light. In his method hydrochloric acid was electrolysed and the gases continually acted on by light in the upper part of the vessel used for the electrolysis, so that recombination took place as rapidly as the gases were formed. In this way a residue of oxygen was found in the electrolysis. But it seems more reasonable to attribute the formation of this oxygen to the decomposition of water vapour by the chlorine under the intense light used.

Because of this supposed impurity, GAUTIER and HÉLIER used hydrogen and chlorine prepared separately. But the difficulties pointed out by BUNSEN and ROSCOE, in obtaining molecular quantities of the gases, introduce very much more uncertainty in the results, when this method is used, than occurs with the exceedingly small quantity of oxygen, if any, evolved in the electrolysis.

The method of GAUTIER and HÉLIER was different from that of BUNSEN and ROSCOE and PRINGSHEIM, in that in their experiments the hydrochloric acid formed remained in the gas mixture, and so modified the action. The period of induction was not studied by them, and in their hands the problem was simply one of mass action.

With the dried gases they find that the rate of action is not proportional to the density of the free hydrogen and chlorine. If M is the quantity of hydrochloric acid at time t , D the density of hydrogen and chlorine, then, if the rate of combination were proportional to the density of hydrogen, we should have

$$\frac{M}{t} = cD; \text{ } c \text{ being a constant.}$$

From their experiments, GAUTIER and HÉLIER deduce the following values for C :—

For the 1st period,	2·5 hours	. . .	$C = \cdot 0217,$
„ 2nd „	3	„ . . .	$C = \cdot 0310,$
„ 3rd „	41	„ . . .	$C = \cdot 0130,$
„ 4th „	191	„ . . .	$C = \cdot 0070.$

* GAUTIER and HÉLIER, 'Comptes Rendus,' vol. 124, p. 1128.

† MELLOR, 'Journal of the Chem. Soc.,' Feb., 1901.

But from the law of mass action we should expect that the rate of combination would be proportional to the square of D or to the product of the densities of hydrogen and chlorine, so that we should have

$$\frac{dD}{dt} = -cD^2, \text{ whence } \frac{1}{D_{t_1}} - \frac{1}{D_{t_0}} = -c(t_1 - t_0).$$

And this gives for C for the same periods as before

$$\cdot 00023, \quad \cdot 00038, \quad \cdot 00024, \quad \cdot 00045.$$

These numbers are not constant enough for any definite conclusion as to the action in this case following the mass action law; but remembering the great effect of impurities, and noticing that in the bulbs used in these experiments from 4.2 to 6 per cent. of air was present, it is surprising that the values of C are so nearly equal.

GAUTIER and HÉLIER also tried the effect of increase in the proportion of one or other of the gases in the mixture, and found that the rate of action was increased, thus contradicting a result of BUNSEN and ROSCOE. The principle of mass action would lead us to expect a decrease in the rate of combination from this cause. For suppose D , D' the concentrations of hydrogen and chlorine in the mixture, x the concentration of hydrochloric acid gas, then

$$\frac{dx}{dt} = CDD', \quad x + D + D' = 1,$$

and

$$D' - D = A, \text{ a constant,}$$

and therefore

$$\frac{dx}{dt} = \frac{c}{4} \{ (1 - x)^2 - A^2 \},$$

which is obviously a maximum when $A = 0$, or when hydrogen and chlorine are present in molecular proportions.

We must accept BUNSEN and ROSCOE'S result in preference to that of GAUTIER and HÉLIER, from the very much better conditions of the experiments of the former observers. In GAUTIER and HÉLIER'S experiments different bulbs were used for each observation, and, further, the amount of impurity present was very indefinite. It is very doubtful if experiments made in different vessels can ever be more than very roughly comparable, as the determination of the factor required to allow for loss of light by reflexion and by absorption by the glass of the bulb is impossible. The absorption of ultra-violet light by the glass makes a large difference in the rate of combination. With bulbs filled with the mixture and exposed, side by side, to diffuse daylight, very different proportions are combined after the same exposure.

GAUTIER and HÉLIER believe the action to take place in more than one stage, oxides of chlorine being formed which are reduced by the action of the hydrogen

present. The oxidation of the chlorine is effected by the water vapour present in the mixture.

They suppose, for example, an action of the following type

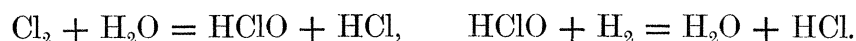

The presence of moisture was found by these observers, as well as by many others, to increase the rate of the action. The question arises, do hydrogen and chlorine combine at all under the influence of light when no water vapour is present? BAKER* found that complete combination did not take place after exposure to bright sunshine for two days. According to PRINGSHEIM, action does occur slowly in the most carefully dried gases.

The catalytic action of water vapour is of great importance in other actions besides the one under consideration. There have been several theories proposed for the explanation of this action, but none of them are very satisfactory. DIXON supposes that the molecules of water undergo decomposition; for example, in the oxidation of carbon monoxide he assumes two stages

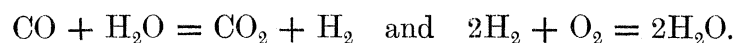

PRINGSHEIM'S theory is that, in addition to this type of action, we have the preliminary dissociation into atoms, which then act with the water molecules

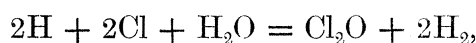

and finally

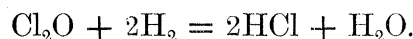

This explanation has been criticised† from the point of view of BERTHELOT'S principle of maximum work. This criticism does seem to be applicable to PRINGSHEIM'S scheme when we are dealing with free atoms of hydrogen and chlorine; but the principle does not necessarily hold when the rates of action between molecules come into consideration. If the action

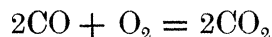

takes place slowly compared with the actions

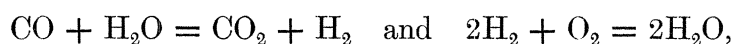

the course of the oxidation of carbon monoxide to carbon dioxide may be as DIXON suggests. And the view in this case is more probable, as it appears from DIXON'S experiments that if the action

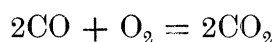

can occur at all it occurs extremely slowly.

* 'Phil. Trans.,' A, 1894.

† 'Brit. Ass. Rep.,' 1894.

PRINGSHEIM'S explanation, however, of the hydrogen and chlorine reaction is not tenable, as when we have free atoms it is hardly conceivable that the complicated action, requiring the meeting of five molecular systems, should occur, and not the direct combination of hydrogen and chlorine atoms.

Another explanation* of the action of water vapour is that hydrogen peroxide is formed by direct oxidation of the water molecule, and that this gives up some oxygen to the other substance taking part in the action. This view is only applicable to oxidation and not to such actions as the combination of sodium and chlorine, which does not occur in the absence of moisture.

This view may, however, be extended, and we may suppose that intermediate compounds, which are purely additive, are formed, and which break down into more stable forms, giving the final result of the action. This hypothesis will be further developed after we have discussed the experimental investigation of the combination of hydrogen and chlorine.

II. EXPERIMENTAL INVESTIGATION.

For the experimental part of this investigation the method of BUNSEN and ROSCOE was in main followed for the study of the initial expansion, or Draper effect, and the period of induction. The mixture of gases was prepared by electrolysis of ordinary pure hydrochloric acid saturated with hydrochloric acid gas. It has already been remarked that oxygen has been supposed to occur in the gases prepared in this way, but this quantity of oxygen is, at any rate, extremely small and seems to be without effect; otherwise it seems impossible to explain the constancy of the results obtained by this method, when we remember the large effect produced by the addition of a very small quantity of oxygen. At any rate, the difficulty of preparing a pure mixture of separately formed gases in the right proportions is so great, that the electrolytic method is far superior to any other.

Several forms of cell for electrolysis were tried. Platinum electrodes are dissolved after some time, so that carbon rods were used, as it was found that they lasted for a long period. The form of vessel adopted consisted of an ordinary lamp chimney sealed to a three-way tap leading to a thistle tube and to the insulation apparatus. The carbon electrodes were fitted through an indiarubber stopper, through which also passed a tube connected with a tap through which the spent acid could be removed while fresh acid was introduced through the thistle tube. In this way there was no fear of introducing air into the apparatus when recharging the cell. Above the stopper a layer of paraffin wax was melted so as to form a paraffin bottom to the cell. This paraffin, after the cell had been in use for several weeks, was apparently unaffected by the acid itself or the chlorine in solution. The cell was continually

* MENDELÉEFF, 'Principles of Chemistry,' I., p. 305.

kept in the dark and was found to work extremely well. Fig. 1 is a diagram of the cell.

The insolation apparatus (fig. 2) was essentially the same as that of BUNSEN and ROSCOE. Considerably larger bulbs were sometimes used to make the Draper effect more evident. The gases from the generating vessel pass through the washing bulbs (*b*) to the tube (*e*) leading to the insolation bulb (*d*). At (*e*) a side tube is sealed, so as to allow the gases when the tap *C* is closed to pass through the water in (*f*) and so out through (*g*) into (*h*), an earthenware pot filled with lime to absorb the chlorine. The clip in (*g*) serves to close this outlet. With (*c*) open, all the gas evolved passes into the bulb (*d*), which contains some water in its lowest part, thence through the capillary tube (*i*) to the bulb (*j*), and thence to the absorbing vessel (*k*), which is similar to (*h*). The bulbs (*d*) used were from 3 to about 8 centims. in diameter. The capillary tubes (*i*) were from 50 centims. to 200 centims. long. The bulb (*j*) has water in it to just above the level of the capillary tube, so that when (*c*) is open the gases bubble through the water in (*j*), and when (*c*) is closed the water runs a few centimetres into the capillary and forms the index defining the volume of the gas in the insolation bulb (*d*). With large insolation vessels it is very necessary that the capillary tube (*i*) should be level along its whole length, as it is easy to see that the water in the capillary may produce changes of pressure in the bulb (*d*), causing corresponding changes of volume which are greater than the effects to be observed unless the tube is horizontal. This tube was usually supported along its whole length on a wooden table. The bulb (*j*) also must be large enough for the alteration of level

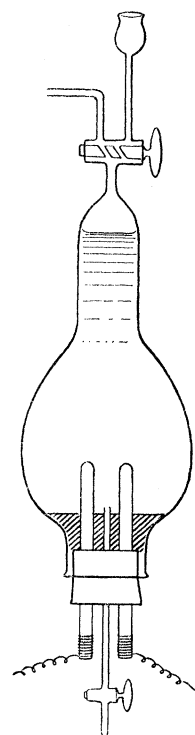

Fig. 1.

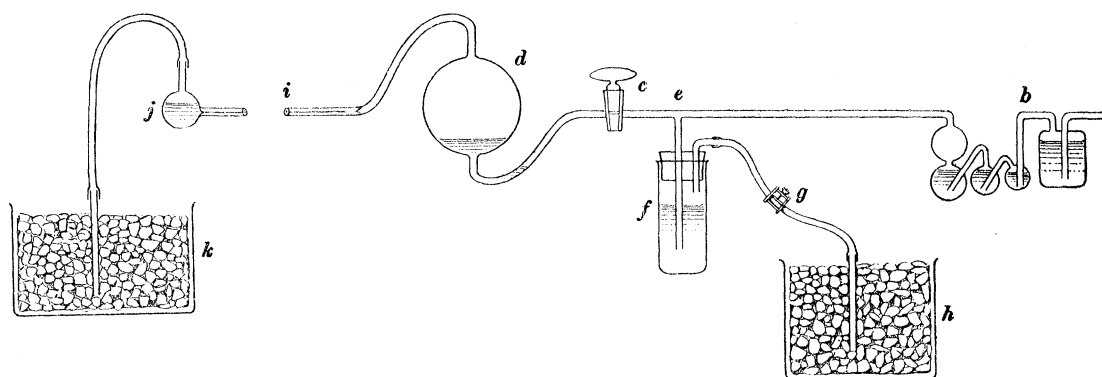

Fig. 2.

of the water in it, due to motion of the index, to be negligible. When practicable, the whole apparatus from the generating vessel to the outlet tube had only glass joints, as indiarubber is soon destroyed by chlorine, and, also, with only glass joints there is no danger of contamination of the gases. The glass joints at the ends of the

capillary had to be carefully made, as slight irregularities occasion the stoppage of the tube by a drop of water at one end or a bubble of gas at the other.

The insolation vessel from the tap (*c*) to the beginning of the capillary tube was enclosed in a wooden box packed with cotton waste to keep the bulb from light and from temperature changes. In the side of the box was a tube of diameter about two-thirds that of the bulb, so that light could be thrown on the upper part of the bulb, the part with water in it being blackened and remaining in the dark. On this tube was fitted a Thornton-Pickard photographic shutter, so that an exposure of the bulb to the light of a given time could be made. With some practice, by counting the ticks of a watch, exposures of one-fifth of a second and upwards could be given with fair accuracy. For the illumination of the bulb a Welsbach incandescent burner was usually used as a source of light. The lamp was enclosed in a box with a hole in it placed opposite to the shutter. The light was passed through a water trough to cut off heat rays, and through a convex lens to be sent down the tube to the insolation vessel in as nearly as possible parallel rays. Other screens were arranged to cut off extraneous light and accidental heating effects from the burner. With these precautions, working in a cellar, the temperature of the insolation vessel could be kept constant for a considerable time. Fig. 3 shows a diagrammatic representation of the arrangements for illumination.

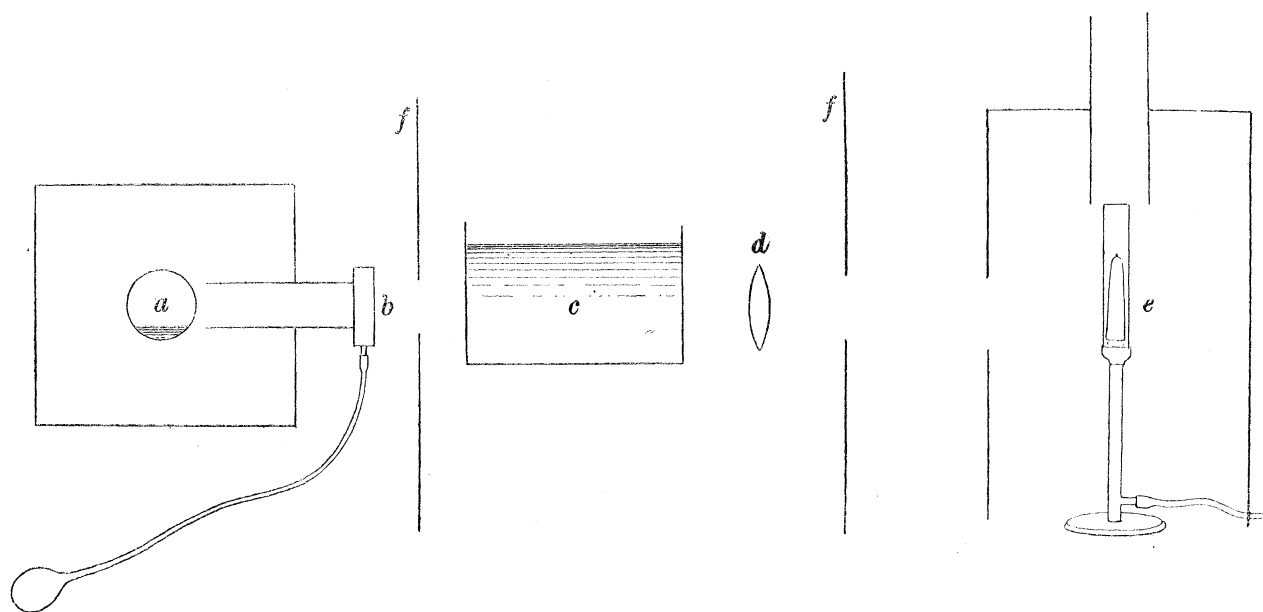

Fig. 3.

It is necessary that the electrolytic gas should be continuously passed through the apparatus for nine or ten days, to thoroughly drive out all air, and to saturate the water in the various parts of the apparatus with chlorine. It was found necessary to run a certain quantity of gas through the apparatus before each experiment, especially if the gases had been standing for some time, as slight changes in

temperature of the whole apparatus alter the solubility of the chlorine, and produce slight changes in the relative amounts of chlorine and hydrogen in the insolation bulb. It was found also necessary not to alter greatly the rate of evolution of the gases. Such alteration produces effects which are probably to be attributed to the alteration of concentration of the solution round the electrodes in the generating vessel, which causes the gases for a time not to be given off in the right proportions. If the rate of evolution is not fast, however, this difficulty gives rise to no trouble. Following BUNSEN and ROSCOE, a small current was kept decomposing the acid continually during a series of experiments, so that there was always a slight excess of pressure inside the apparatus above that outside; in this way all danger of small quantities of air being drawn into the apparatus was avoided.

In the first experiments performed the light of the sky was used, but this proved to be much too variable, so the Welsbach burner was employed. In some of the later experiments an incandescent electric lamp was used, and, for instantaneous illumination, a spark from a Ruhmkorff coil with several Leyden jars in circuit.

If a not too powerful source of light be used, the phenomena observed when the light falls on the mixture are as follows:—For some time the water index remains stationary; but after a certain time, depending on the intensity of the light, the water index begins slowly to move towards the insolation bulb, indicating a decrease in the volume of the gas under observation caused by the absorption in the water at the bottom of the bulb of the hydrochloric acid formed. The rate of this motion increases at first slowly, that is, the acceleration is at first small. The acceleration increases to a maximum and then decreases to zero, when a maximum rate of action is reached which remains constant. The curves (fig. 4) represent the results of an experiment of this kind, showing the general phenomena of the “Period of Induction.” The curve I has for abscissæ the time in minutes from the beginning of illumination, and for ordinates the observed contraction from the beginning of the experiment, measuring the amount of hydrochloric acid formed. The curve II is the velocity curve for the same experiment.

If the light be more intense the phenomenon known as the Draper effect appears. Instead of the period of inertness when the water index does not move, the index, immediately on illuminating the gases, moves away from the insolation bulb, showing an increase in the volume of the gas mixture. With very intense light this expansion can be made to increase in magnitude practically without limit, until the point is reached when explosion takes place. And this suggests at once that the phenomenon is a heat effect. The expansion may continue for as long as half-a-minute (there seems no reason why it should not continue for a longer period, the only difficulty being that with more intense light the whole apparatus is likely to explode). But after a time the expansion stops and at once the gas begins to contract; and then the general phenomena are the same as when no expansion occurs. If the illumination is stopped before the expansion is complete, contraction

immediately follows, and the final volume is one which is less than the original volume.

When the light is cut off, after or before the steady velocity of contraction has

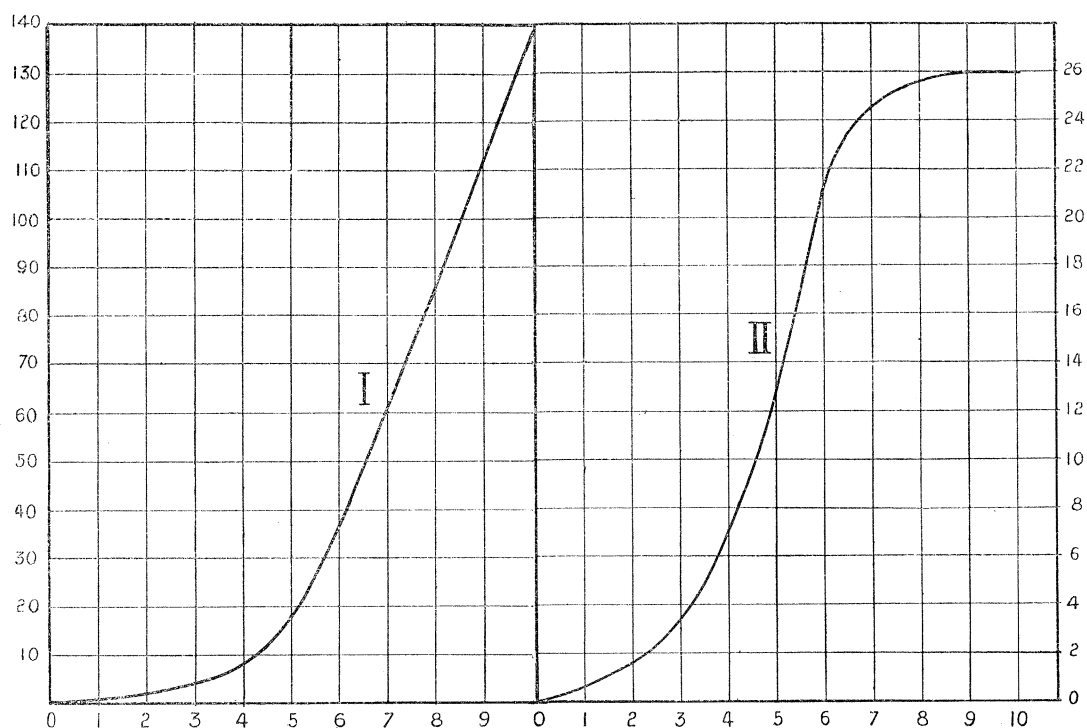

Fig. 4.

been reached, the rate of contraction at first increases, reaches a maximum, and then decreases until the index comes to rest.

The phenomena to be investigated thus fall under three heads:—1. The initial expansion. 2. The final contraction (when light has been cut off). 3. The period of induction proper.

1. *The Initial Expansion.**

This expansion can, as we have seen, be made exceedingly large. But with light of suitable intensity it can be kept within manageable limits.

PRINGSHEIM has worked at this phenomenon, but his conclusions have not been confirmed in this investigation. The following experiments were therefore made very carefully and in considerable detail.

* The results of this section were published in the 'Proceedings of the Cambridge Philosophical Society,' vol. 11, Part IV., 1902. J. W. MELLOR published almost simultaneously the fact that hydrogen chloride is formed during the momentary illumination producing the initial expansion. He also afterwards arrived at the conclusion of § 5 with regard to the expansion of damp chlorine alone under the influence of light. MELLOR'S investigations are in the 'Journal of the Chemical Society,' 1901, 1902.

§ 1. *The Relation of the Initial Expansion to the Time of Insolation.*

The first point considered was the relation of the expansion to the time of illumination, the intensity of the illumination remaining constant.

The influence of very small quantities of impurity was found to be merely to diminish the quantity of effect observed, not to alter the quality of the effects, so that impure gas and more intense light give the same effects as pure gas and less intense light. This is useful practically, as there is no need to take so much time for preparing the purest mixture obtainable in order to observe the qualitative effects in the initial expansion.

In fig. 5 are plotted the results of four series of experiments. In each series the light was of constant intensity. For any single observation the illumination was for the time represented as abscissa and the expansion observed was that represented as ordinate.

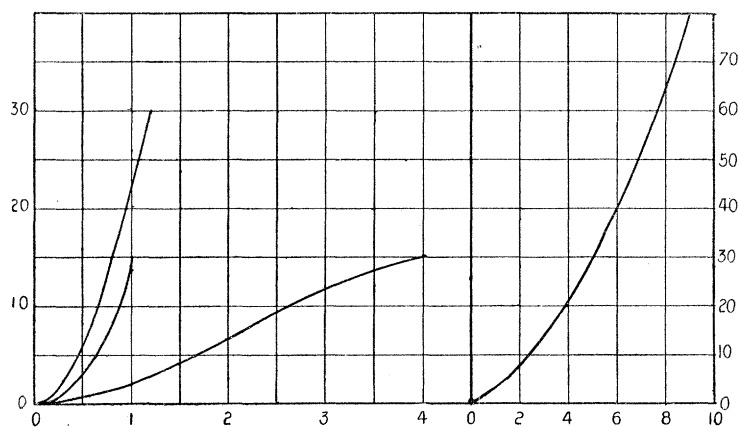

Fig. 5. Abscissæ, time in seconds. Ordinates, expansion.

Between each observation the bulb was left for a quarter of an hour in the dark, so that one experiment should not affect the next.

These curves show that we have an increasing rate of expansion with the increase of the time of illumination. The relation between the expansion and the time of illumination was also determined, in the course of one expansion, by marking the position of the index at intervals of one second after the beginning of illumination. With rapid motion of the index this method is difficult, but it has the advantage over the other method of following the whole course of the expansion in one experiment.

In the following table are given the results of experiments of this kind. The numbers in the last three columns represent the positions of the index at the time stated in the first column.

Time from beginning of insolation.	Expansion.		Experiment III.
	Experiment I.	Experiment II.	
1	3	3	5
2	18	26	22
3	34	51	41
4	47	73	59
5	60	90	79
6	73	106	91
7	84	119	105
8	92	128	115
9	99	131	123
10	104	132	130
11	107	—	132
12	108	—	—

These experiments also show that the rate of expansion increases with the time of illumination at first and then diminishes until the expansion is complete. After this, contraction at once sets in. Now it might be thought that this observed increase in the rate of expansion might simply be due to the inertia of the water index in the capillary tube—the viscosity of the water would tend to diminish the acceleration of the expansion. To perform a series of experiments that would eliminate this effect of inertia a series of illuminations, each lasting for one second, was made. Each illumination followed quickly on the preceding one, only sufficient time being allowed between the illuminations for the index to come nearly to rest. The actual interval between the observations below was from 10 to 15 seconds. In the following tables are given in the first column the numbers of the illumination of one second from the first, which was made with fresh gas that had always been in the dark. In the second column is the expansion observed for each illumination. The intensity of the light was different in the different experiments.

I.		II.	
Number of illumination.	Expansion.	Number of illumination.	Expansion.
1	3	1	7
2	4	2	11
3	6	3	14
4	6	4	22
5	6.5	5	20
6	8	6	23
7	7	7	33
8	12	8	30
9	11	9	25
10	11	10	33
11	12	11	30
III.		IV.	
Number of illumination.	Expansion.	Number of illumination.	Expansion.
1	10	1	28
2	12	2	39
3	14	3	37
4	20	4	44
5	26	5	46
6	29	6	51
7	35	7	60
8	33	8	73
9	35	—	—
10	45	—	—
11	39	—	—

After IV. the same gas was allowed to remain in the dark for three minutes, and was then again illuminated for one second. The expansion was 52. The mixture was again allowed to remain dark for six minutes, and the expansion for one second illumination was 29. Therefore in three minutes the gas has not attained its original condition. But six minutes is enough as far as the expansion is concerned to enable the gas to return to its initial state.

These experiments conclusively show that the expansion, for a definite quantity of light, depends not only on the amount of light, but also on the condition of the gases. In other words, *the expansion is dependent on the state of the induction.*

In every case in the above experiments some hydrochloric acid was formed, and the position of the index was such, therefore, that in each series of experiments a longer column of water had to be moved in each expansion than in those preceding it. The expansion, therefore, in any case is probably a little too small compared

with the one preceding it. The effect of this is to make the acceleration of the expansion less than it should be. There remains no doubt that the acceleration exists. The reason that these experiments were made in such detail was that PRINGSHEIM* concluded that the amount of the expansion for a given quantity of light is independent of the state of the induction. It was partly on this conclusion that he based his theory that the first action of the light is to cause a dissociation of hydrogen and chlorine molecules into atoms.

§ 2. *The Relation to the Hydrochloric Acid Formed.*

The next point to be considered is the relation between the initial expansion and the hydrochloric acid formed. Experiments on this subject are considerably more difficult than experiments on the expansion alone. For the complete contraction, defining the amount of hydrochloric acid formed, takes a considerable time, and so very small and slow changes of temperature of the whole apparatus may cause relatively large errors. The expansion is complete in seconds, while the contraction requires minutes to come to an end. For this reason numbers expressing contraction are not very regular. It is also difficult to obtain a long series of comparable experiments, since small changes of the conditions of temperature and pressure alter the behaviour of the gas mixture by changing the relative proportions of hydrogen and chlorine in the mixture. In this way experiments from day to day may differ, even when the most careful precautions are taken for complete saturation of all the liquids involved.

The curves in fig. 6 represent the results of one experiment on the relation between the initial expansion and subsequent contraction representing the hydrochloric acid formed. In curve A the abscissæ represent the contraction (hydrochloric acid formed), the ordinates the initial expansion. In B are plotted the contraction and the ratio of initial expansion to the contraction. C is the early part of A enlarged.

The result obtained from such experiments is that the initial expansion is always followed by contraction, showing the formation of hydrochloric acid. The ratio of the expansion to the final contraction below the original volume increases as the final contraction diminishes. This is to be expected if the expansion be due to heat arising from combination, for the shorter the time of illumination the less heat can escape.

With the object of obtaining as short exposures as possible, the mixture was illuminated by the light from electric sparks. The sparks were obtained from an induction coil with several Leyden jars in circuit. No special care was taken to obtain sparks of constant length, the object being to see if, with instantaneous illumination, any hydrochloric acid at all was formed. The size of the spark could however be regulated so as to give expansions from 1 millim. of the capillary tube

* 'Wied. Ann.,' 1887, vol. 32, p. 412.

upwards. Single sparks were obtained by working the contact breaker with the hand. The result obtained, from a large number of experiments, was that, however quickly illumination takes place, an expansion is always followed by a contraction,

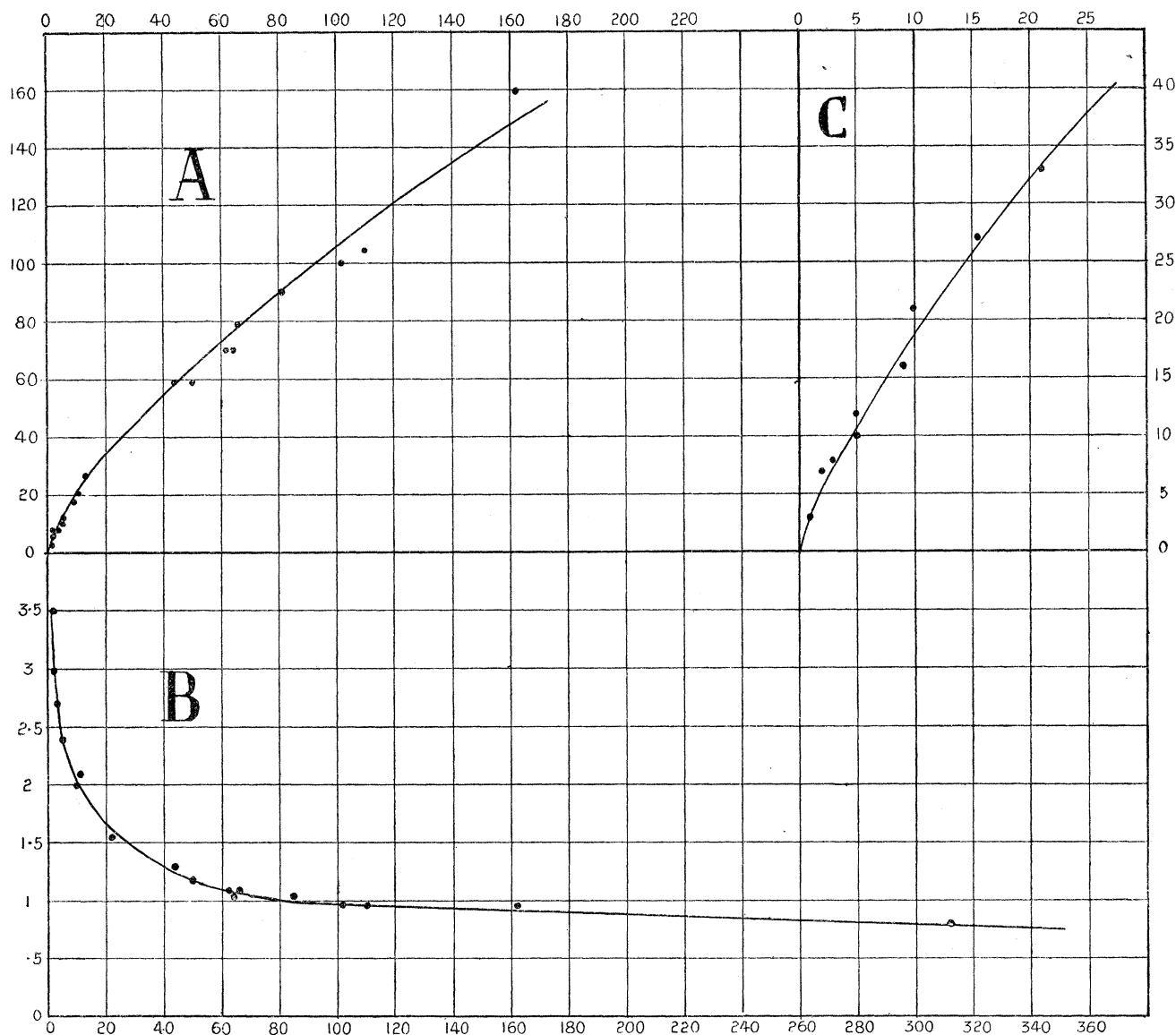

Fig. 6.

showing the formation of hydrochloric acid. For the smaller contractions noted the index was carefully watched with a lens to detect the small contraction.

The following table shows the results of some experiments, illumination being by a single spark :—

Expansion.	HCl formed.	Ratio.	Expansion.	HCl formed.	Ratio.
1	·2	5	3·5	1·7	2
1	·3	3	4	2	2
1·2	·2	6	4	1·5	2·6
1·3	·2	6·5	5	3	1·7
1·5	·3	5	5·2	1·6	3
1·5	·6	2·5	6·5	2	3·2
1·5	·2	7·5	8	3	2·7
1·5	·4	4	8	4	2
3·5	1	3·5	12	4	3

As the index even with an instantaneous illumination takes a finite time to move, all the heat liberated by the combination of the hydrogen and chlorine will not contribute to expanding the gas, but some will be dissipated in the walls of the insolation vessel and the water contained in it, so that the larger the amount of hydrochloric acid formed with instantaneous illuminations of different intensities, the smaller will be the ratio of expansion to contraction. This we find to be the case in the above experiments. The ratio tabulated diminishes as the contraction representing the hydrochloric acid formed increases. Thus, however small the initial expansion, we can conclude that there is always some hydrochloric acid formed. This conclusion was arrived at also by MELLOR ('Chemical Society's Transactions,' 1902).

§ 3. *The Temperature Change Associated with the Initial Expansion.*

The next series of experiments were made to determine directly the change of temperature in the mixture of gases, when light falls on it, during the period of expansion. The method employed was to find the change in the resistance of a platinum wire in the gas mixture during illumination. A large insolation bulb (about 8 centims. in diameter) was used for this purpose. A piece of platinum wire, .001 inch in diameter and about 9 centims. long, was welded at each end to a stout wire of the same metal, and these stout wires were sealed into the bulb at opposite sides, so that the fine wire hung loosely in the insolation bulb. The wire was then connected with a Post Office resistance box in the ordinary Wheatstone bridge arrangement. A differential galvanometer was used, which could be easily made as sensitive as was required. The temperature coefficient of the wire was found *in situ*, and agreed very nearly with that of another specimen of the same wire. The galvanometer was so adjusted that the change of resistance of the wire in the insolation bulb was determined by reading the displacement of the spot of light on the galvanometer scale. The resistance of the wire at 0° C. was 20·650 ohms, and a change of resistance of 1 ohm corresponded to a change of temperature of 23° C.

It was found that on illumination of the gas mixture the resistance of the wire increased, indicating a rise in temperature of the mixture.

The curve represented in fig. 7 has for abscissæ the final contraction, indicating the amount of hydrochloric acid formed, measured in millimetres of the capillary tube, and for ordinates the rise in temperature observed. The points all lie about a line which at first is straight; and the deviations from this line are not greater than are to be accounted for by the unavoidable errors of experiment.

In this experiment then, there is an observed rise of temperature which for the cases when the amount of hydrochloric acid formed is small is proportional to the

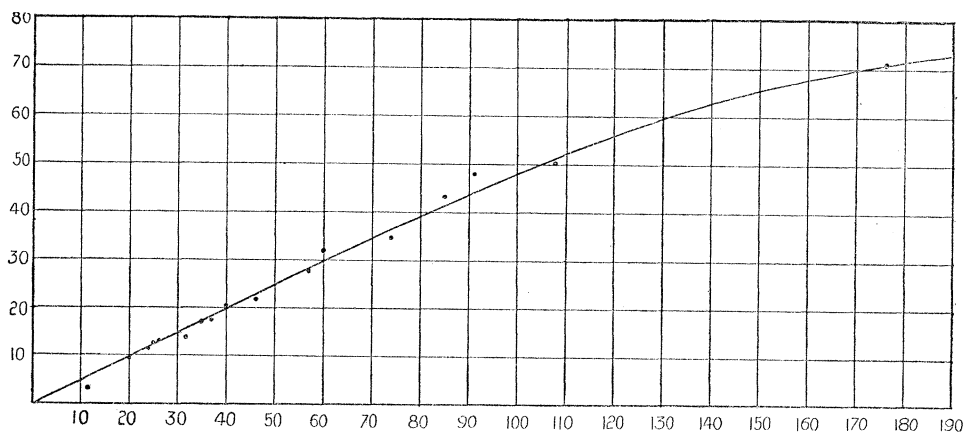

Fig. 7.

amount of hydrochloric acid formed. The time of illumination for these experiments was very short for the observations represented by the straight part of the curve, the illumination only lasting for a fraction of a second. (The longest illumination was about 1.5 second.)

With the galvanometer made as sensitive as possible, a rise of temperature was always indicated with the shortest illuminations obtainable by means of an electric spark. Even when the illumination was adjusted so that the only observable effect on the index was an expansion of a small fraction of a millimetre, a rise of temperature could always be detected.

§ 4. *Conclusions.*

We conclude that under all conditions there is associated with the initial expansion a formation of hydrochloric acid and also a rise in temperature.

Taking THOMSEN'S value 22,000 cal. for the heat of formation of hydrochloric acid, the increase of volume of an equal mixture of hydrogen and chlorine, supposing all the heat expended in expanding the resulting hydrochloric acid, is such that the new volume equals 10.5 times the old volume. In the vessel used, in the experiments just detailed, a formation of hydrochloric acid, corresponding to a contraction of 1 millim. of the index, would cause a rise in temperature in the gas of very nearly $.01^{\circ}$ C. In all cases the actual rise observed was less than this, so that the observed rise in

temperature is fully accounted for by the heat of formation of the hydrochloric acid. We have already seen that the expansion is larger compared with the contraction, representing hydrochloric acid formed, the smaller the quantity of acid formed and the shorter the time of insolation; but the ratio of these two quantities always falls considerably below 10·5. For the bulb used, a rise of temperature of $\cdot 01^{\circ}$ C. corresponds to an expansion of about 9 millims. of the scale, and in no case was the expansion observed as large as that value which would correspond to the observed rise in temperature. The reason that this value of the expansion is not observed is that the motion of the index is relatively slow, and the gas cools so quickly, with very short exposures, that the index cannot register the expansion corresponding to the total rise in temperature.

The conclusions then with regard to the initial expansion period are :—

- (1) The expansion is due to rise in temperature of the gas mixture ;
- (2) This rise in temperature is caused by the heat liberated in the formation of hydrochloric acid.

The initial expansion period is therefore nothing more than a part of the period of induction as studied by BUNSEN and ROSCOE; and the condition necessary for the existence of the Draper effect is that the intensity of the light should be such that the combination can begin rapidly enough for the heat evolved to produce an observable effect.

§ 5. *The Expansion of Chlorine alone under the Influence of Light.*

In connection with this subject the results of experiments of BUDDE* and BAKER,† on the expansion produced in chlorine alone by the influence of light, are of interest. BUDDE found that under the influence of light damp chlorine expanded. In his first paper‡ he states that the expansion cannot be due to a rise of temperature, but in a later series of experiments he found that a rise in temperature did occur, and although the rise in temperature did not agree with the expansion very well, he concluded that the expansion was a direct result of the heat resulting from the absorption of light. BAKER found that perfectly pure and dry chlorine did not change its volume when exposed to light.

PRINGSHEIM§ showed that this expansion was very different from that in the Draper effect. With the most intense sparks procurable, there is no observable expansion in chlorine alone.

It seemed worth while, with the apparatus already described, to settle the question

* BUDDE, 'Phil. Mag.,' 1871, vol. 42, p. 290.

† BAKER, 'Brit. Ass. Rep.,' 1894.

‡ BUDDE, 'Pogg. Ann.,' vol. 6, 1873, p. 477.

§ PRINGSHEIM, 'Wied. Ann.,' 1887, vol. 32, p. 413.

with regard to damp chlorine. The light from a Welsbach burner was allowed to fall on the bulb already described, and the rise in temperature and expansion were observed. The expansion was proportional to the rise in temperature as far as the accuracy of the method admits.

The following table gives the expansion, the rise in temperature, and the expansion for $\cdot 01^{\circ}$ C. obtained in a series of experiments of this kind.

Expansion.	Rise in temperature.	Expansion for $\cdot 01^{\circ}$ C.
	$^{\circ}$ C.	
48	$\cdot 068$	7.05
50	$\cdot 053$	9.4
50	$\cdot 060$	8.3
73	$\cdot 092$	7.9
85	$\cdot 113$	7.5

The mean of the numbers in the last column is 8.03. From the dimensions of the bulb and capillary tube a rise of temperature of $\cdot 01^{\circ}$ C. should produce an expansion of 8.2 scale divisions. It thus appears that the expansion observed is accounted for by the rise in temperature of the gas. To test whether the slight warming of the apparatus affected the expansion, by liberating some of the chlorine dissolved in the water in the bulb, the rise in temperature of the chlorine was observed and the expansion due to the warming of the room during the course of the day. This expansion was very slow and was 9 scale divisions for a rise of temperature of $\cdot 01^{\circ}$ C. The amount of chlorine, therefore, evolved is so small that it can be neglected.

2. *The Final Contraction.*

On cutting off the light after insolation has been proceeding, an increase in the rate of contraction is first observed. For example, the mixture of hydrogen and chlorine was exposed to light, and a continuous supply of fresh gas was kept running into the insolation bulb, to keep the index on the scale. After the maximum rate of action was reached—observed by stopping the supply of fresh gas for a short time—the light was cut off and the time of contraction through various lengths of the index scale noted. Fig. 8 represents the course of the contraction. The maximum action, when the light was on the mixture, was about 100 scale divisions in 4 seconds. It will be noticed that the initial rate of contraction, after the light was cut off, was about 100 scale divisions in 2 seconds. The behaviour on darkening before the maximum rate of action is reached is shown in the curves in fig. 9. In each case the phenomena are essentially similar to the case when the action, before light is cut off, has reached its maximum value. The rate of contraction is, on cutting off the light, greater at first than before the darkening, and gradually diminishes until the index comes to rest.

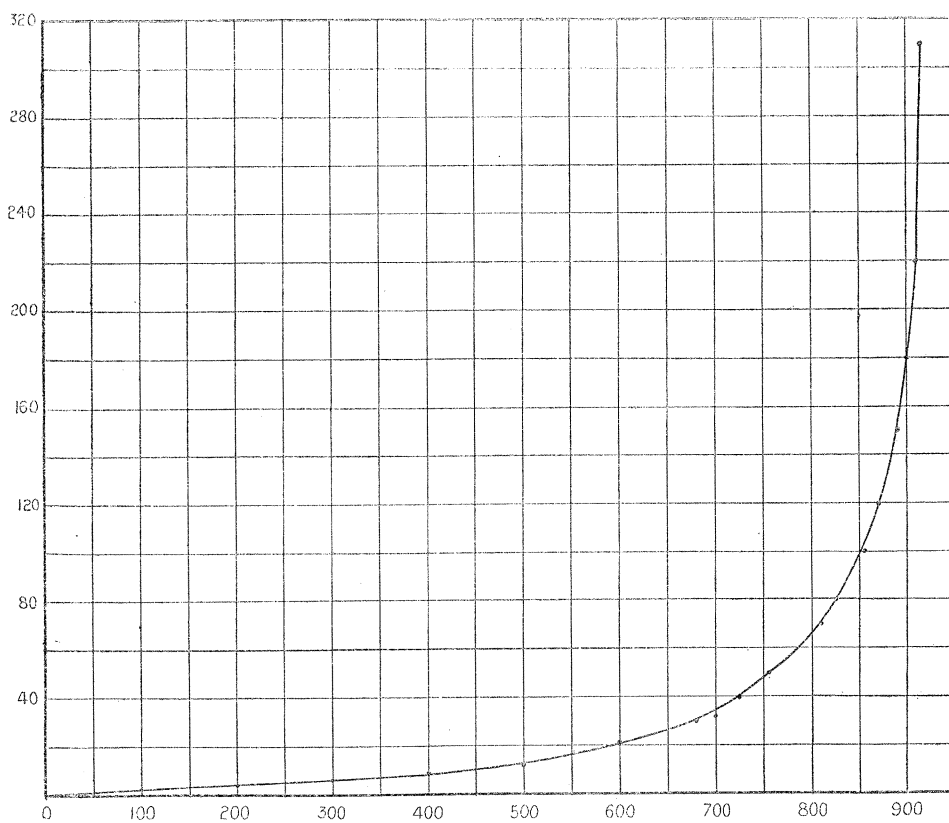

Fig. 8. Abscissæ, contraction from the time of cutting off light.
Ordinates, time in seconds after cutting off light.

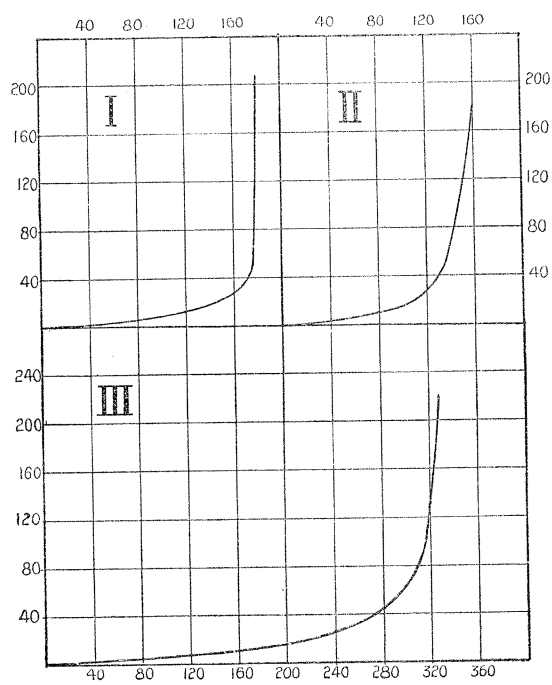

Fig. 9.

There are three causes to which this final contraction may be attributed :—(1) The cooling of the gas which has been heated by the combination ; (2) Continuation of the action, hydrochloric acid being formed for some time after darkening ; (3) Absorption of hydrochloric acid formed while the light was acting.

BUNSEN and ROSCOE concluded that the effect was due to the first cause, but the amount of contraction in their experiments was too small for much reliance to be placed in their result.

With the platinum thermometer used in earlier experiments it was easy to decide how much of the contraction was due to the first cause. The gas was illuminated ; on darkening, the temperature was found to fall as the contraction proceeded, and it was found that the contraction agreed, within the limits of accuracy of the experiment, with that corresponding to the fall in temperature.

The following two tables give the results for two series of experiments of this kind. In the first column is the observed fall in temperature, in the second the change of volume due to this fall, in the third the observed change of volume, and in the fourth the ratio of the numbers in the third and second columns.

Change in temperature in ° C.	Change of volume corresponding to change of temperature in first column.	Observed change of volume.	Ratio.
·28	230	240	1·04
·41	336	320	·95
·41	336	320	·95
·42	344	360	1·05
·42	344	395	1·15
·35	287	315	1·12
·43	353	353	1·00
·44	361	335	·93

The mean of the numbers in the last column is 1·024.

Change in temperature in ° C.	Change of volume corresponding to change of temperature in first column.	Observed change of volume.	Ratio.
·085	69	53	·77
·101	83	98	1·18
·146	120	150	1·25
·192	157	160	1·02
·283	232	232	1·00
·308	253	250	·99
·321	263	316	1·20
·341	280	280	1·00
·401	329	360	1·09
·401	329	340	1·03
·462	380	398	1·04
·481	394	400	1·01
·504	413	402	·97
·640	525	455	·87

The mean of the numbers in the last column is 1·030.

The contraction therefore, after the light is cut off, is nearly all due to cooling. If any hydrochloric acid is absorbed after darkening, it is very little, and we conclude that the formation of hydrochloric acid stops almost instantaneously when the light is cut off, and that the hydrochloric acid is absorbed almost as soon as it is formed.

3. *The Period of Induction.*

The problem is now simplified to a great extent. The Draper effect and the final contraction have been shown to be due to temperature effects, which complicate the initial and final phenomena. Fig. 4 represents the general course of the induction which takes place under all conditions of illumination. On illumination, hydrochloric acid is formed at first very slowly, the rate of formation increases, the acceleration of the rate of formation increases until a maximum acceleration is reached; then the acceleration decreases to zero, when the rate of action becomes constant, if the gases are present in the mixture in molecular proportions; if there be excess of one gas, the final rate gradually diminishes as the relative quantities of the two gases become more and more different.

We shall at present confine ourselves to the case when the gases are present in approximately molecular proportions, so that all through the experiments the amounts of uncombined gases are present in the same relative quantities.

§ 1. *Prolongation of the Period of Induction.*

In BUNSEN and ROSCOE'S experiment the period of inertness was never found to be more than 6 or 7 minutes. If, however, a much less intense light be used the

induction period may be prolonged indefinitely, so that an interval of some hours may occur between the beginning of insolation and the formation of hydrochloric acid in large enough quantities to be observed.

In the following two experiments the time to the first visible contraction showing formation of hydrochloric acid was in the first 48 minutes, and in the second 178 minutes.

I.		II.	
Time from illumination in minutes.	HCl formed.	Time from illumination in minutes.	HCl formed.
48	0	177	0
50	5	178	1
51	10	180	3
53	24	184	9
55	39	188	17
60	86	190	23
70	214	194	41
—	—	201	81
—	—	205	104

The bulb used for these experiments was a large one, about 8 centims. in diameter, and the capillary tube was about 150 centims. long, so that the induction could be followed for a long time.

§ 2. *The Effect after Darkening.*

When feeble light is used for insolation the effect that remains after the light is cut off can be detected for a very considerable time. The effect is that after the gas has been illuminated and then darkened, on again illuminating the period of induction is shorter than in the first instance. That is, that all effect of the light does not cease when the light is removed. We have seen that the formation of hydrochloric acid stops almost immediately, but the gases are in a condition when they can combine more readily under the influence of fresh light. The gas is in a condition of insolation. In BUNSEN and ROSCOE'S experiments this effect could not be detected after about 15 minutes in the dark, but it can be prolonged, and in one experiment was detected after the gas mixture had remained in the dark for over 22 hours. With more intense light the visible effect passes off in a very much shorter time, giving results agreeing with those of BUNSEN and ROSCOE. (For example, in the experiment on p. 85, the effect as far as it affected the initial expansion passed off in about 6 minutes.)

In figs. 10, 11, 12, 13 are represented experiments on this effect. The light

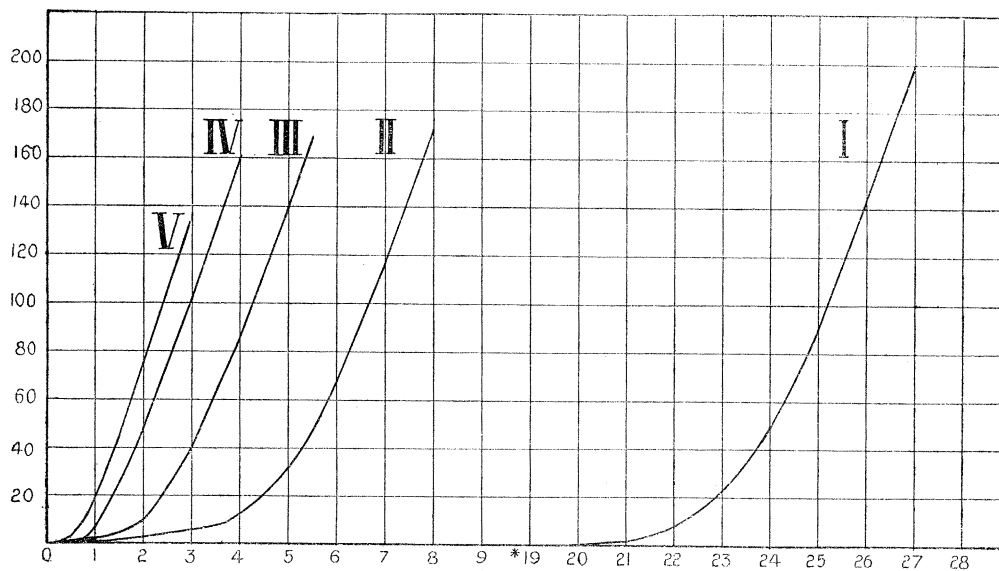

Fig. 10. Abscissæ, time after illumination in minutes.

Ordinates, HCl formed.

Curve I, induction in fresh gas.

„	II	„	„	gas which had been darkened for 1 hour.
„	III	„	„	„ „ 15 minutes.
„	IV	„	„	„ „ 5 „
„	V	„	„	„ „ 0.5 „

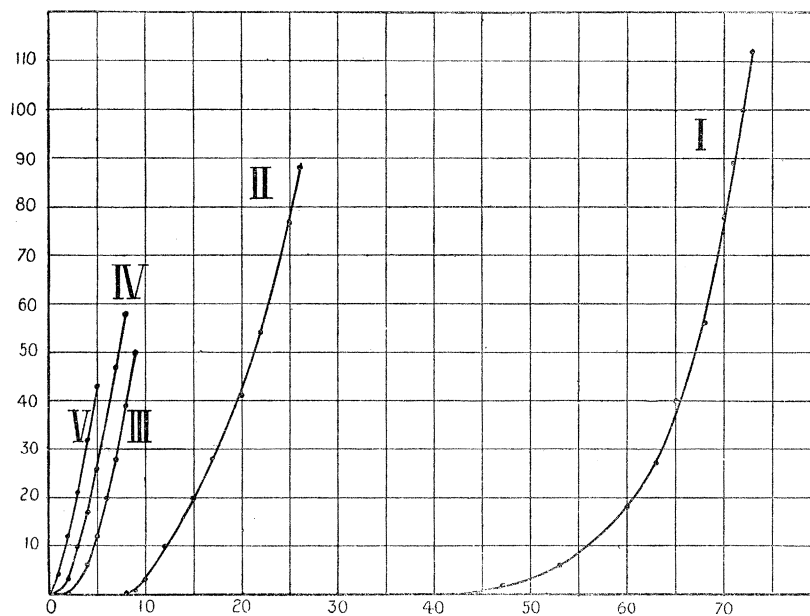

Fig. 11. Abscissæ, time after illumination in minutes.

Ordinates, HCl formed.

Curve I, fresh gas. Curve II, $4\frac{1}{2}$ hours dark. Curve III, 12 minutes dark.
Curve IV, 5 minutes dark. Curve V, 1 minute dark.

intensity was different for the four series of experiments, but the same through each series. The insolation vessels also were not all the same, so that the curves are not comparable except in each separate series. In fig. 12 the curve representing the experiment with fresh gas is not plotted, as the inert period in this case was about

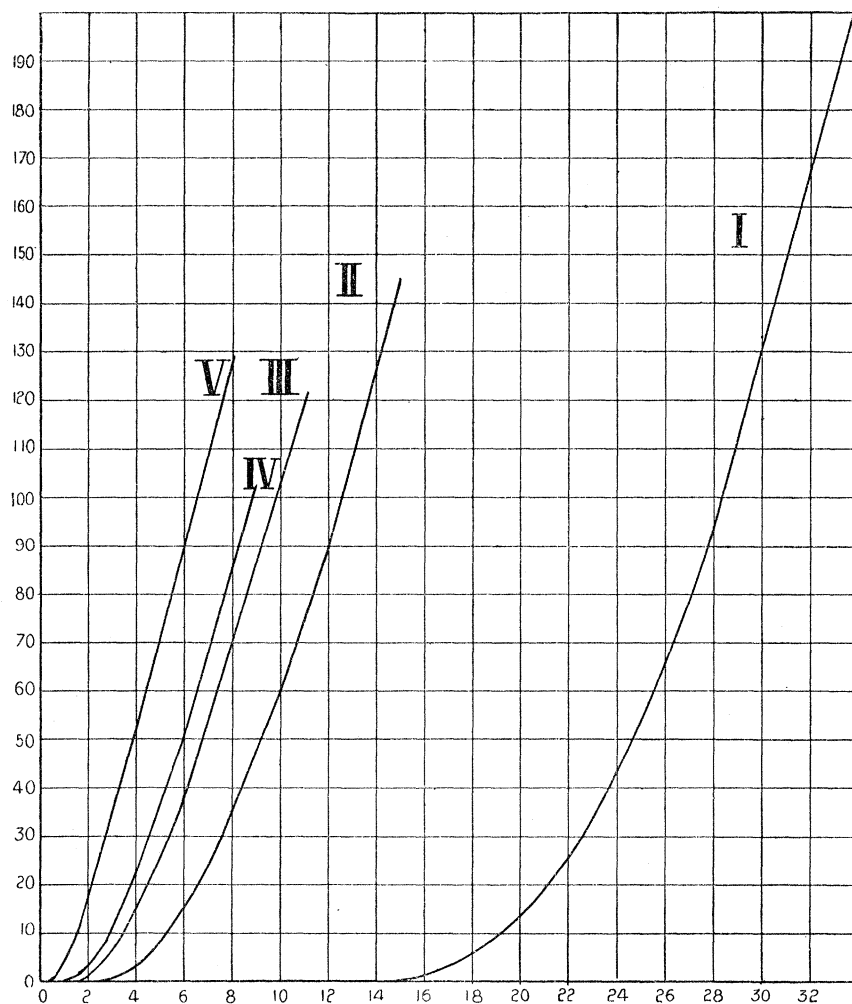

Fig. 12. Abscissæ, time in minutes from beginning of illumination.

Ordinates, HCl formed.

Curve I, 1 hour dark. Curve II, 15 minutes dark. Curve III, 10 minutes dark.

Curve IV, 5 minutes dark. Curve V, 1 minute dark.

90 minutes, and hence the curve could not be placed on the same diagram as the others of the same series without crowding unduly the other curves.

With the same insolation vessel, and different intensities of light, the maximum action is proportional to the intensity of the light. (See BUNSEN and ROSCOE, 'Photochemical Researches,' Part II., p. 387.) BUNSEN and ROSCOE also showed that the time of exposure necessary to effect the first combination decreases with

the increase of intensity of the light, and in a greater ratio than the increase of light, and that the time of exposure to reach the maximum action decreases with increase

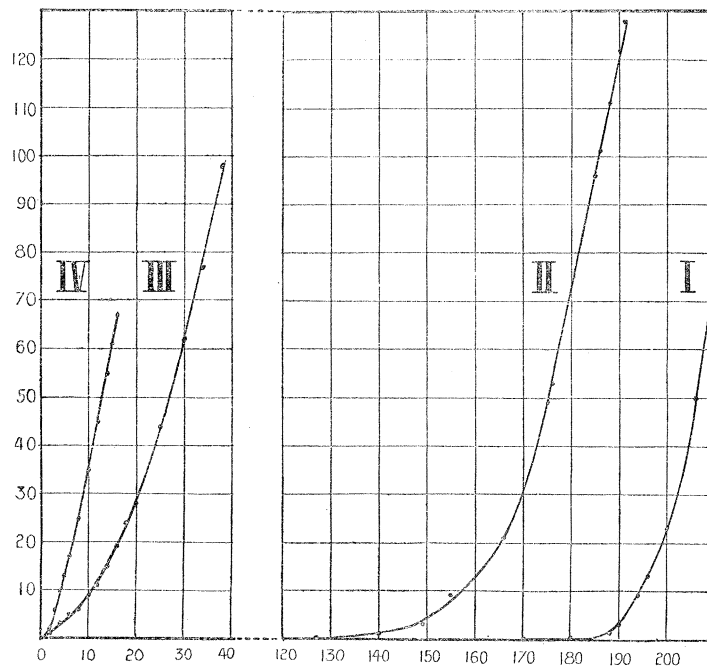

Fig. 13. Abscissæ, time in minutes from beginning of insolation.
Ordinates, HCl formed.

Curve I, fresh gas. Curve II, after 22 hours dark. Curve III, after $\frac{1}{2}$ hour dark.
Curve IV, after 5 minutes dark.

of light, but in a less ratio than the increase of the light. These conclusions were confirmed, but as they were so well established by BUNSEN and ROSCOE, there is no need to give the results of any of the experiments on these points.

§ 3. *The Effect of Impurities.*

One of the most remarkable facts connected with the action under consideration is the large effect on the rate of combination produced by a small quantity of impurity. BUNSEN and ROSCOE showed that the addition of $\frac{5}{1000}$ parts of oxygen reduced the maximum action from 100 to 9.7. It is extremely difficult to prepare the gas mixture with a definite quantity of impurity in it, and as yet no experiments have been performed which are sufficiently comparable to determine the relation between the quantity of the impurity and the rate of the action. To quote the words of BUNSEN and ROSCOE: "It is perfectly useless to collect the electrolytic gas in a large vessel, then mix it with the impurity, and afterwards to allow the mixture to pass through the apparatus, for there is no possible means of collecting this pure mixture of hydrogen and chlorine in large masses, and again forcing it out in a given

direction." In fact, any operation with the gas mixture is sufficient to alter its properties. The only method of procuring reliable results is to evolve the impurity required from a second electrolytic vessel and to pass it continuously through the apparatus together with the normal mixture for some days, using the same current for producing the hydrogen and chlorine and the impurity. However, even under

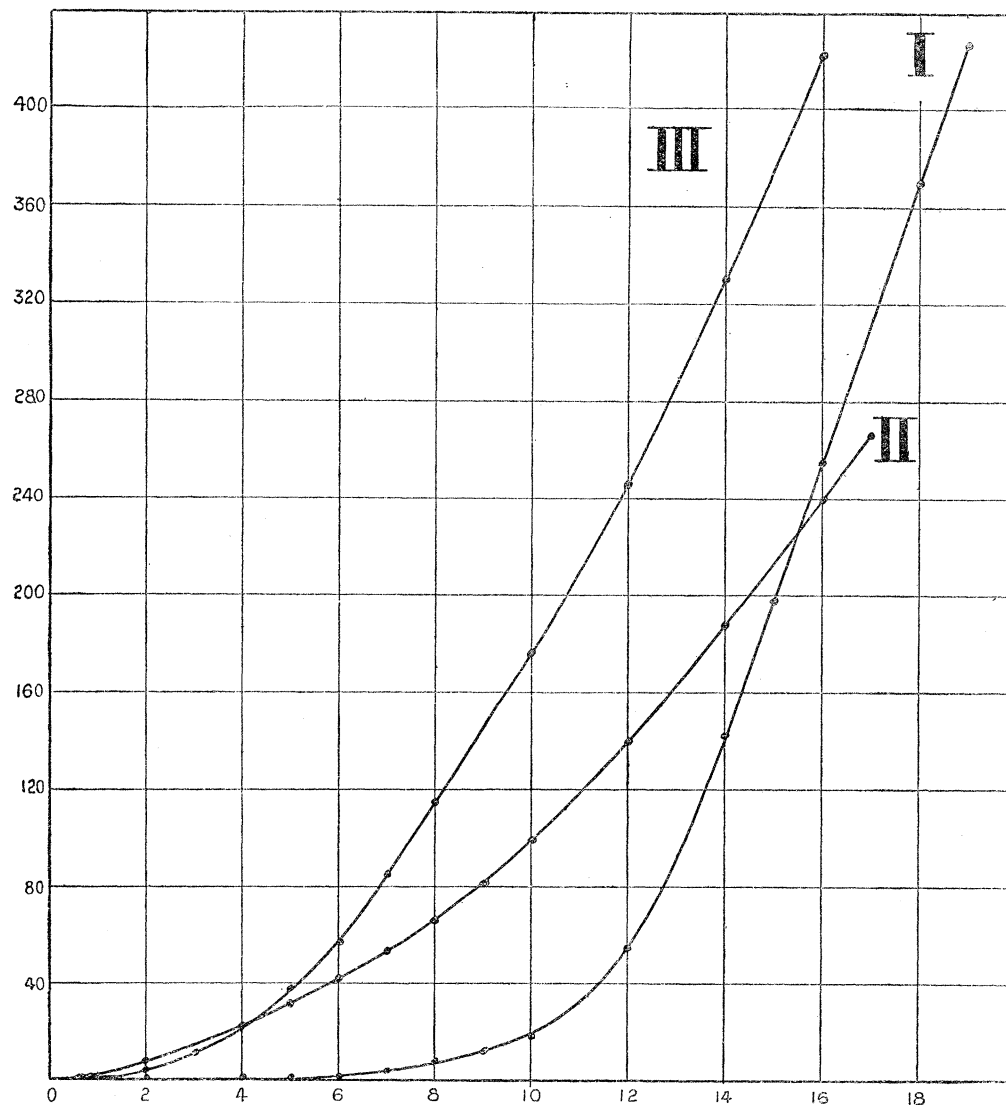

Fig. 14. Abscissæ, time from beginning of action in minutes.
Ordinates, HCl formed.

these circumstances, the results obtained are not in any very close agreement. The only conclusion arrived at is that the effect of impurity is large at first, but the effect increases in a much less ratio than the amount of impurity.

There is one form of impurity, however, which is not subject to such experimental difficulties as occur with others, and that is the unisolated gas mixture itself. The

uninsolated gas can easily be introduced into the insolation vessel while the action is progressing. If this be done, a large decrease in the rate of action is at once noticed, and the combination may cease altogether if sufficient quantity of gas be introduced. Then an induction period sets in as in the case of a fresh gas mixture. But the attainment of the original maximum is only performed gradually compared with the case of the fresh gases. This will be made clear by the experiments represented in fig. 14. At first the gas was illuminated and, after a period of inertness of about 20 minutes, the acceleration period represented in curve I, fig. 14, took place. After the maximum action had been reached, a quantity of uninsolated gas, occupying about 400 millims. of the index tube, was introduced while the light was still on the mixture. The index came to rest and an inert period of about 1 minute occurred. The acceleration period then set in, but was very much longer than in the case of the original gas; in fact, the rate of action was increasing slowly for as long as the index could be followed, and the maximum action was not attained. This is shown by the curve II, fig. 14, being very much flatter than curve I.

If the mixture be left in the dark for some time before illuminating, after fresh gas has been added, this retarding effect passes off to some extent, and the attainment of the maximum action is not so gradual. Curve III, fig. 14, represents the occurrences when the same gas as for curves II and I had again about 400 millims. of fresh uninsolated gas added, and was then darkened for 5 minutes. The action is seen to

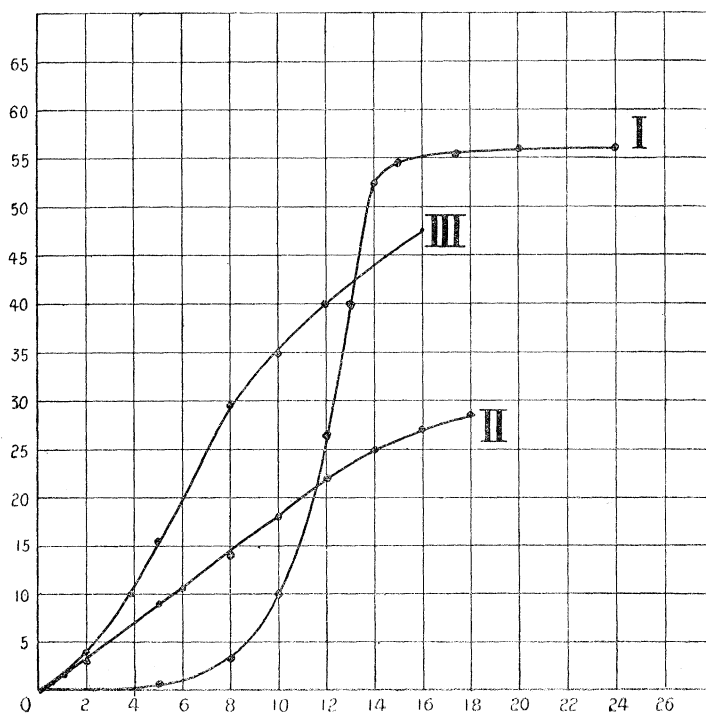

Fig. 15. Abscissæ, time in minutes from beginning of action.
Ordinates, velocity of action.

be intermediate between that of the fresh gas and that when the light is kept on continuously while fresh gas is added.

The effect of the added uninsolated gas thus persists for some time and makes itself evident by the prolongation of the acceleration period. This is shown still more clearly on curves for the velocity of the action. In fig. 15 the curves I, II, III are the velocity curves corresponding to the curves in fig. 14. It is at once obvious from these curves that after the admission of uninsolated gas the attainment of the maximum action is slower than when action has begun after all the gas has been uniformly insolated. The fresh gas thus apparently exercises a retarding effect as long as it has not been brought to the condition of the rest of the gas. Mere contact with the insolated gas diminishes this retarding effect, since the maximum is reached sooner after the gases have stood for some time in the dark. This is shown by curve III in fig. 15 being intermediate in character between curves I and II.

The effect of admission of uninsolated gas increases with the quantity of fresh gas added. The velocity curves change from the type (1) to the type (2) as the quantity of fresh gas is increased.

§ 4. *The Effect of Previous Insolation of the Separate Gases.*

It has already been stated that DRAPER found that previous exposure of chlorine to light produced an increase in the rate of action, when the chlorine was mixed with hydrogen and exposed to light.

This conclusion was contradicted by BUNSEN and ROSCOE, but the explanation of this contradiction is that the chlorine in BUNSEN and ROSCOE's experiment was bubbled through water, after it had been illuminated, and this destroys the effect.

To investigate this effect two inverted burettes were placed side by side, the open ends dipped under water in a trough and the burettes were filled with water. Chlorine was slowly passed into the burettes, one of which was darkened by enclosing it in a metal tube. The tube had a slit through which the volume of the gas could be read. By passing the chlorine slowly into the tubes, the water in them becomes almost saturated, so that solution of chlorine in the water does not take place to any appreciable extent during an experiment. After the chlorine in the tube exposed to diffuse daylight had stood for two or three minutes, this tube was also darkened and approximately the same quantity of hydrogen was introduced into the two burettes, so that in each tube there was an approximately molecular mixture of the two gases. The tubes were then left for some time to give the gases opportunity for thoroughly mixing, and then the two tubes were simultaneously exposed to the light. Combination took place, the hydrochloric acid formed being absorbed by the water, which rose in the burettes, and thus afforded a means of measuring the velocity of the combination. In every case the tube which originally had been exposed to light with chlorine in it showed a greater velocity of action at the beginning. In some

cases the originally darkened tube in a short time showed a more rapid action, but this occurred only after some time. In the following experiments the tubes were interchanged after each experiment—the one with darkened chlorine in one experiment being used for the illuminated chlorine in the next experiment, and *vice versa*. The times of the observations were not recorded, but the water levels were read at the same instant, as all that was required was the relative rate of combination. The light used, being diffuse daylight on a bright day, caused fairly rapid combination, and the whole of an experiment occupied only from 30 seconds to 1 minute.

EXPERIMENT 1.

No. of reading	1	2	3	4	5	6	7	8
Contraction in tube containing hydrogen and illuminated chlorine }	2	4	6	10	12	14	16	18
Contraction in tube containing hydrogen and non-illuminated chlorine . . . }	·5	2	5	12	15	18	20	22·5

EXPERIMENT 2.

No. of reading	1	2	3	4	5	6	7	8
Contraction in tube containing hydrogen and illuminated chlorine }	3	6	10	13	15	16	18	20
Contraction in tube containing hydrogen and non-illuminated chlorine . . . }	0	1	3	6	10	13	17	19

EXPERIMENT 3.

No. of reading	1	2	3	4	5	6	7	8	9	10	11	12
Contraction in tube containing hydrogen and illuminated chlorine }	2	5	11	13	14	15	16	17	18	19	20	25
Contraction in tube containing hydrogen and non-illuminated chlorine . . . }	0	1	5	7	8	10	12	13	14	14·5	15	18

Experiments were also made with the chlorine in both tubes treated similarly—both tubes darkened or illuminated before the admission of hydrogen. The contraction observed was similar in the two tubes, and so the initial increase in the case of the tube with insolated chlorine is due to the fact that the chlorine has been influenced by the light. These experiments were frequently repeated with different conditions of illumination, and in every case the phenomena were as in the experiments just tabulated.

No difference in the initial rate of combination could be detected if the hydrogen was first illuminated, and then mixed with chlorine in the dark, and the mixture exposed to light.

If the chlorine be exposed to light in a separate vessel, and then introduced into the burette through the water and mixed with hydrogen, the behaviour was as if it had not been exposed to light at all. The process of bubbling through the water thus washes out the substance in the chlorine which causes the difference between the insolated and non-insolated chlorine.

The anomalies observed in the final rates of formation of hydrochloric acid in these experiments are to be attributed to the differences in the mixtures in the two burettes. It is impossible to obtain with this method two exactly similar mixtures, and the effects of small changes in the composition of the mixture are large. If an excess of chlorine be present in the mixture, the results with different tubes are fairly comparable, much more consistent results being obtainable than with an excess of hydrogen. This fact agrees with BUNSEN and ROSCOE'S result, that a small excess of hydrogen makes a very much greater difference in the rate of combination than that produced by the same excess of chlorine.

The effect of insolating the chlorine alone passes off if the chlorine and hydrogen mixture be left in the dark for some time. The behaviour is then similar to that of the ordinary insolated mixture.

There is, therefore, a change produced by the action of light on moist chlorine alone, which is apparent when the chlorine is caused to combine with hydrogen. DRAPER considered that an allotropic modification of chlorine was produced, which combined more readily with hydrogen than ordinary chlorine. It seems more probable that the effect is due to some action between the chlorine and the water vapour, which is always present in these experiments. For water vapour, if not absolutely necessary to the action, assists it very materially.

This view is also supported by the fact discovered by BAKER,* that perfectly pure and dry chlorine does not expand when exposed to light, while damp chlorine does so expand. We have already seen that the expansion of damp chlorine is attended by a development of heat. There is then, at any rate, some evidence that the first stage of the action to form hydrochloric acid is an action between chlorine alone and water vapour.

§ 5. *Expansion Experiments.*

To obtain further evidence of the existence of intermediate bodies in the initial stage of the action between hydrogen and chlorine, use was made of the expansion method of C. T. R. WILSON to discover if any cloud-forming nuclei were produced by the influence of light on the gas mixture. The apparatus was that described by

* BAKER, 'Brit. Ass. Rep.,' 1894.

WILSON,* so that a sudden expansion of adjustable amount could be produced, as often as was desired, in the same sample of the gas mixture. Great difficulty was found to arise from the action of chlorine on the indiarubber stopper used for stopping the descent of the piston. Several artifices were tried to overcome this difficulty,

which was never entirely removed. By covering the stopper with a thin coating of a mixture of solid paraffin and vaseline, if care was used in filling the bulb used, so that as little chlorine as possible should come in contact with the stopper, a single stopper could be made to hold a few days.

The expansion bulb, cylinder and piston, are represented in fig. 16. The rest of the apparatus was the same as in WILSON'S experiments, and requires no further description. The method of reading the amount of the expansion was to measure the distance the piston descended in any experiment. After a series of experiments, the instrument was calibrated by attaching to one of the exits from the bulb a manometer, so that the distance travelled over by the piston could be expressed in terms of the change of pressure produced in the expansion bulb. The only part of the apparatus on which the chlorine could act was the stopper on which the piston falls; the taps to the exits were lubricated with water, and one tube leading into the bulb was sealed to the delivery tube of the generating and washing apparatus, which was the same as described on pp. 78 and 79.

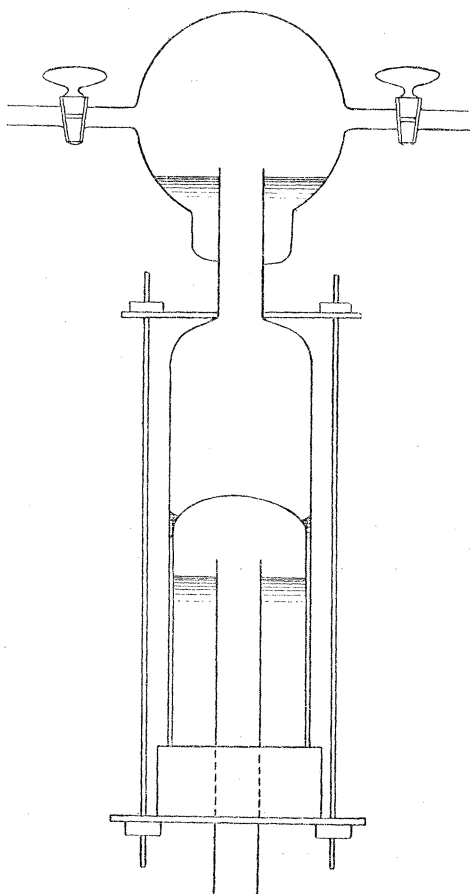

Fig. 16.

The experiments with this apparatus showed that when light is allowed to fall on a mixture of hydrogen and chlorine, a nucleus-forming substance is produced, which causes condensation on a certain definite supersaturation. This condensation appears when an expansion is made greater than a certain definite quantity, and no condensation appears with the same expansion unless the gas has been illuminated. With chlorine alone the condensation appeared when the chlorine had been illuminated, and it was absent when the chlorine had not been illuminated. To observe the cloud or the absence of the cloud in non-illuminated gas, the image of a bat's-wing gas flame was formed in the bulb, the light previously having passed through yellow glass. The cloud produced in gas that had been illuminated was easily seen when illuminated by the bat's-wing flame, so that the difference between

* 'Cambridge Phil. Soc. Proc.,' vol. 9, p. 333.

the "dark" and "light" expansions is not to be attributed merely to the difficulty of observing the cloud in the former.

(1.) *Experiments with Chlorine alone.*—C. T. R. WILSON showed that in dust-free chlorine a slight rain-like condensation took place, when an expansion, measured by P_1/P_2 , greater than 1.30 and less than 1.45, was made. P_1 is the pressure before expansion, P_2 after expansion. With P_1/P_2 greater than 1.45, a cloud-like condensation occurs, increasing in thickness as the amount of expansion increases. In the present experiments the cloud-like condensation was observed to begin at $P_1/P_2 = 1.50$ approximately, and up to this value there were only a few scattered drops observed on expansion, when the chlorine was darkened. If, however, the chlorine be strongly illuminated, the phenomena are very different. The number of drops increases as the expansion increases from $P_1/P_2 = 1.27$ up to the value 1.46, when a thick fog is the result of the expansion. The following table represents the observations in a series of experiments of this kind:—

P_1/P_2 .	Observation.
1.21	No drops seen.
1.24	" "
1.27	A few drops.
1.30	Fine rain.
1.33	" "
1.36	More rain with finer drops.
1.41	Thick rain.
1.43	Rain cloud.
1.46	Thick cloud.

If the chlorine be darkened, after a few expansions to precipitate nuclei left by the evaporation of the cloud, the behaviour is similar to that of the original chlorine; only a few drops are seen until the expansion reaches the limit $P_1/P_2 = 1.5$.

These experiments were repeated several times with light of varying intensity. The same result appeared always, so that it is clear that ordinary light (not ultra-violet light) produces in damp chlorine some substance which can act as nuclei for condensation.

(2.) *Experiments with the Mixture of Hydrogen and Chlorine.*—In the dark, expansions with P_1/P_2 less than 1.42, only a few drops were observed. With the expansion greater than this amount, the fog-like supersaturation cloud appeared.

With the mixture illuminated, the results were similar to those obtained with chlorine alone. The formation of drops began when the expansion was such that $P_1/P_2 = 1.22$, the number increasing with increasing expansion, until a thick cloud was produced with $P_1/P_2 = 1.36$. If the intensity of the light was altered, the cloud's thickness altered, but the same variation between the limits, 1.22, 1.36, occurred.

The next experiments made were to determine the effect of the time of illumination

on the formation of nuclei. For this purpose an expansion corresponding to $P_1/P_2 = 1.35$ (about) was used, as this expansion was well under the expansion required to produce condensation in the uninsulated gas. The following two tables give the results of two series of experiments, one with dim, the other with bright light :—

I. DIM Light. $P_1/P_2 = 1.35$.

Time of insolation.	Observation.
1 second	Only one or two drops observed.
10 seconds	Several drops.
30 "	Fine rain.
40 "	" "
60 "	Rain cloud.
4 minutes	Cloud indistinguishable from the last.
10 "	" " "

II. BRIGHT Light. $P_1/P_2 = 1.35$.

Time of insolation.	Observation.
1 second	Fine rain.
2 seconds	More rain.
3 "	Cloud.
5 "	Thick cloud.
10 "	Cloud indistinguishable from the last.
1 minute	Same cloud.

Experiments were next made on the gas after the illumination was cut off. The mixture was illuminated for some minutes before each expansion, and then the mixture was darkened and an expansion corresponding to $P_1/P_2 = 1.36$ made after the time in the first column.

Time from darkening to expansion.	Observation.
10 seconds	Thick cloud.
1 minute	" "
2 minutes	Cloud less than in last experiment.
5 "	Rain cloud.
10 "	Fine rain cloud.
1 hour	Fine rain.
2 hours	A few drops.

With chlorine alone similar results were obtained.

The fact that the cloud produced in the mixed gases is similar to that produced in

chlorine alone suggests that in the mixed gases it is the chlorine alone that is efficient in producing the nuclei, and that the hydrogen is inactive. It might be expected that the cloud in the mixture might be formed on hydrochloric acid molecules produced after the illumination. But the cloud-forming nuclei appears before any hydrochloric acid is formed in measurable quantity, as the following experiments show. The expansion apparatus was joined to the ordinary insolation apparatus of fig. 2, and the two illuminated with the same light. The time to the first appearance of motion of the water index, indicating the absorption of hydrochloric acid, was noted. Expansions were also made and the character of the cloud after different times of illumination observed. In all cases the cloud produced on expansion had reached its densest appearance a considerable time before the hydrochloric acid began to be formed. The following numbers will show the kind of phenomena observed :—

Time to the first motion of water index of insolation apparatus 29 seconds.

Time of insolation before expansion in expansion vessel $P_1/P_2 = 1.38.$	Observation.
1 second	Rain.
2 seconds	Rain cloud.
5 „	Thick cloud.

and no change in the character of the cloud appeared with longer exposures.

For more careful experiments of this kind a long capillary tube was sealed to the exit tube of the expansion bulb, in which a drop of water served as an index, so that the expansion bulb itself could be used as the insolation bulb (fig. 17). If the tap

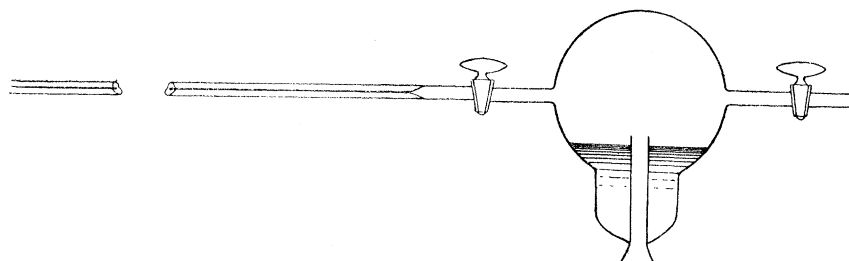

Fig. 17.

between the capillary tube and the expansion bulb was open, the drop of water in the index tube defined the volume of the gas in the expansion bulb; and the rate of formation of hydrochloric acid in the bulb could be followed by noting the motion of the index drop. With the same tap closed an expansion could be made of the same

sample of gas. After the expansion had been made, the piston of the expansion apparatus could be allowed to return to its original position, and then, on opening the tap communicating with the capillary tube, the effect of the expansion on the rate of combination could be observed.

With this apparatus it was shown that the nuclei, on which condensation took place on expansion, appeared before any hydrochloric acid was produced. The effects were very much like those on p. 107. The hydrochloric acid is formed only after about five times the illumination required to produce the maximum cloud.

If after hydrochloric acid has begun to be formed an expansion is made, the formation of hydrochloric acid stops if the expansion is large enough to produce a cloud. If no cloud is formed, the expansion being less than corresponding to $P_1/P_2 = 1.2$ about, then the hydrochloric acid formation is not affected. In an experiment of this kind, the inert period was found to be about 30 seconds. A cloud producing expansion was then made and, after allowing this cloud to settle, the piston was returned to its original position, and communication made with the capillary index tube; after the first motion of the index due to the adjustment of pressure between the capillary and the bulb the index remained at rest for 16 seconds, and after this began to show formation of hydrochloric acid again. The bulb was darkened for a short time after the expansion to allow the cloud to settle, but the effect of the darkening on the succeeding inert period was very small. An exactly similar experiment, excepting in the amount of the expansion, showed that when no cloud was formed there was no inert period in the second instance.

There is, therefore, some substance produced by the action of the light on the chlorine and water vapour which acts as condensation nuclei. The formation of this intermediate substance is necessary for the production of hydrochloric acid, and the removal of this substance by expansion and consequent precipitation stops the action when hydrochloric acid is being produced, and the induction period has to begin over again.

§ 6. *Experiments with Dried Gases, and other Experiments.*

(1.) *Experiments with Dried Gases.*—With dry gases the action is much less rapid than with damp gases. But the general phenomena of induction are the same when sufficiently intense light is used. There is a period of inertness and of acceleration. Absolutely dry gases have probably never been prepared, but the rate of combination diminishes as the gas mixture is made less moist. In a bulb with phosphorus pentoxide and the gas mixture combination is very slow even in direct sunlight.

(2.) *Effect of Röntgen Rays.*—Röntgen rays were found to have no effect on the combination. In the dark they produce no action; and no effect was found when the rays fell on the gas when combination was taking place under the influence of light.

(3.) *Radium Rays*.—The rays from a specimen of radium were found to produce no effect after two hours.

(4.) *Hydrogen Peroxide*.—Hydrogen peroxide was introduced into the insolation bulb, and the effect was, as in the case of other impurities, to diminish the rate of action.

III. THEORY OF THE ACTION.

At present there is nothing that can be called a satisfactory theory of chemical action. In nearly all cases the process of an action is very much more complicated than is expressed by ordinary chemical equations. These represent only the initial and final stages which are observed. For example, in actions between electrolytes in solution the individuals taking part in the change are ions and not the salts themselves; and in gaseous systems there appears to be, in very many cases, the necessity for some catalyser to be present for any action to occur. The law of mass action has proved very fruitful as the foundation of chemical kinetics, but the most successful applications of this law have been in cases of actions between molecules in solution, and when gaseous actions have been used as subjects of investigation for the application of this law, the results have only in a few cases* been in agreement with what the law would lead us to expect. Even in these instances the initial stages of the actions have not been studied, so that the agreement with the expected results is only for the case when the action has progressed for some time. The hydrogen and chlorine action is the one to which most attention has been paid in the initial stages, and the initial phenomena do not at all agree with those to be expected from equations derived on the ordinary chemical kinetic theory.

The case of solutions is different from that of gases, as the action is between ions, and the mass law applies at once, for the final products result from direct combination of ions. In gaseous systems, however, we have at the beginning of the action stable gaseous molecules, and the production of the final compounds requires a decomposition, so that the atoms which originally were united become separated and attached to different atoms. An action of this kind therefore involves at least two steps—a decomposition and a composition. In most gaseous actions, in addition to the gases themselves necessary for the formation of the final products, some catalyser is also necessary for the action to proceed with a finite velocity.

The case of a gaseous action is thus still further complicated. In addition to the change from the one form of stable molecule to another, there is the part played by the catalyser to consider. Water vapour is the most commonly-occurring catalyser of this kind, and the natural assumption to explain its action is that intermediate compounds with the molecules of the re-acting gases are formed. We are thus led to

* For example, "The Decomposition of AsH_3 and PH_3 ," KOOLJ, 'Zeit. Phys. Chemie,' vol. 12, p. 155; "The Formation of H_2S and H_2Se , and the Formation of HI ," BODENSTEIN, 'Zeit. Phys. Chem.,' vol. 29.

consider the question of unsaturated and molecular compounds, and first of all, the doctrine of Valency. This doctrine, in spite of its very great use in the systematization of organic chemistry, has to some extent retarded progress by affording too rigid a view of chemical compounds. Until we possess a dynamical conception of a molecule, the theory of bonds can only be regarded as a method of expression of general facts, and not in the sense of giving a representation of actually existing links between atoms. Valency at present has no bearing on compounds which have been called molecular. But no line can be drawn between these compounds and definite atomic compounds. The fact of the existence of such controversies as that as to whether phosphorus penta-chloride was an atomic compound or a molecular compound of phosphorus trichloride and chlorine shows that there is really no difference in kind between these two classes of compounds. Compounds which are saturated under certain circumstances can under other circumstances combine with other systems, so that the difference between saturated and unsaturated compounds is merely one of degree. "Apparently the only saturated molecules known to us at present, molecules destitute of all power of exercising an external influence, are those of gases such as helium and argon."* There is therefore in all molecules, excepting those of the inert gases of the atmosphere, a tendency to form more complicated molecules, some residual affinity which is in many cases unaccounted for on the Valency theory. The difference then between molecular and atomic compounds is a difference of stability under certain conditions, and we must recognise that it is possible for additive compounds of all degrees of complexity to exist, provided that the conditions are suitable. In this connection, the views of NEF† with regard to certain organic substitutions are of importance, as suggesting an explanation of reactions which can be applied to gaseous systems with which we are specially dealing. NEF supposes that reactions take place by unsaturated molecules—compounds exhibiting double linking, or compounds with unsaturated atoms—forming additive compounds with other molecules; afterwards this additive compound breaks down into the final product of the action. For agreement with the Valency theory, NEF supposes that one of the compounds, at the moment of formation of the additive molecule, is dissociated. For example, consider the action of bromine on benzene. In this case, bromine is the unsaturated molecule



This combines with the benzene molecule, which undergoes a dissociation at the moment of combination, forming the molecule

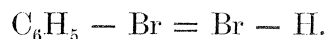

* ARMSTRONG, 'Encyc. Brit.,' Supplement, 1902, Art. "Chemistry."

† NEF, 'Liebig's Annalen,' 1897, vol. 202.

And finally this molecule breaks down into the more stable condition

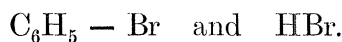

There is no necessity for the action to be brought into formal agreement with the theory of Valency. We can think of the benzene molecule forming a molecular compound with the bromine molecule, in which system the individual atoms can exert forces on each other, so that an internal re-arrangement of atoms in the additive molecule can take place, resulting in an unstable molecule which breaks down into the final products. This conception gives us a reasonable picture of the process of substitution. We do not consider the atoms in a molecule as rigidly attached at certain definite positions with regard to the molecule, but whatever the forces between atoms may be, in the molecule all atoms can act on each other. Thus if a bromine molecule as a whole be brought into close enough proximity to the benzene molecule, then a bromine atom and a hydrogen atom form, at first as part of the molecule, a system without much effect external to itself and so without much connection with the molecule, in other words, the complex additive molecule is unstable and the HBr molecule splits off.

This view is in effect very much that of KEKULÉ* on double decomposition. If two bodies aa' , bb' react, giving ab , $a'b'$, then at first there is a union and afterwards a decomposition. KEKULÉ represents the process thus:—

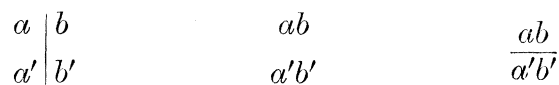

before action, during action, after action.

A somewhat similar view is that proposed by ARMSTRONG, but here a group of three species, forming a voltaic circuit, is introduced, which seems unnecessary and gives really no simplification. ARMSTRONG extends his view to include all actions. But actions which occur in solution are very much more simply explained, on the theory of electrolytic dissociation, as direct combinations. There are probably in gaseous systems cases of simple combination, though in the great majority of cases the action is more complex. An example of this simple combination in gaseous systems is probably to be found in the case of the action of chlorine on mercury. The action occurs when the substances are perfectly pure and dry (SHENSTONE), and there appears to be no reason to suppose that anything except direct combination takes place. But in very many gaseous actions the direct combination does not take place, at any rate with measurable velocity, and some catalyser is necessary. The experiments of BAKER, DIXON and others on the behaviour of pure gases show that in most

* KEKULÉ, 'Liebig's Annalen,' 1858.

cases the actions represented by the ordinary equations of chemistry do not occur. For example, the actions

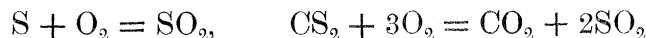

do not take place, unless at a very high temperature. But, in the presence of water vapour, action goes on readily and the final products are the substances represented on the right-hand side of the above equations. Now these actions can all be explained on similar lines to those already put forward to explain the formation of the $\text{C}_6\text{H}_5\text{Br}$ molecule. The distinctive character of the explanation is in the assumption that an additive complex molecule is formed at first before the final products are obtained. In most gaseous actions of this type water vapour is a necessary condition of the progress of the reaction. Now there is no molecule which shows a greater tendency to form additive compounds than water. This property is seen in the molecular species which contain water of crystallization. BRÜHL has investigated many other "unsaturated" properties of water and attributes them to the quadri-valency of oxygen, but for our purpose all we need to recognise is the fact that the water molecule tends to form molecular compounds. The part played by the water in a gaseous action we can suppose as follows: The gaseous substance which takes part in the action can unite with the water molecule directly forming a molecular compound. This new complex molecule can then exist for some time, during which its component atoms can re-arrange themselves, so that an internal settling down to equilibrium takes place. In this process a group of atoms may form a part of the whole molecule, which has little attraction for the rest of the molecule, so that it may split off and give rise to a molecule of the final product. We have in effect in this scheme an intermediate compound, but we recognise the possibility of this compound being not capable of isolation, and in many cases so unstable that its own existence may be practically for an infinitesimally short time.

Such a theory as the one now put forward requires direct evidence as to the existence of the compounds assumed, and, further, that it should lead to expressions for the velocity of the action consistent with the observed phenomena. We shall later on discuss the particular case of the hydrogen and chlorine combination; at present we shall examine some of the general results of the theory.

First of all, to define the kind of actions to which this theory can apply, we may divide chemical actions into four classes. We shall not consider actions which go on with a large change of energy, as under these circumstances the conditions of the action change altogether during the progress of the action, but for our purpose we shall suppose the action slow enough for the whole process to be practically isothermal. The first class is that in which the actions are simple combinations. For example, when an Ag ion combines with a Cl ion and forms an AgCl molecule. The

second when the action is a simple decomposition, such as occurs when a complex sulphur molecule dissociates into simpler molecules. The third when a re-arrangement of atoms takes place in a molecule; and the fourth where the actions are complex and consist of firstly a combination and finally a breakdown of a complex molecule into simpler molecules. In this class it appears probable that all true substitutions and double decompositions should be placed.*

If we apply the Law of Mass Action to actions of the first three classes, we find in very many cases good agreement between the calculated and observed results for the velocity of the actions. But for the fourth class the case is different, as may be seen from an example.

Consider a double decomposition represented by



In the ordinary theory this is a bi-molecular reaction, and the equation for the rate of action is $dx/dt = kyz$, where x is the number per unit volume of molecules of AC or BD and y, z are the numbers per unit volume of molecules of AB and CD; we suppose that the action in the reverse way does not take place. For simplicity, let $y = z$ and $x = n - y$, so that AB and CD are originally present in the same concentration, n molecules per unit volume. Integrating the equation, we have

$$\frac{1}{y} - \frac{1}{n} = kt.$$

But if the intermediate compound ABCD exists, we must take into consideration another step in the action. Let w be the number of ABCD molecules present, then we should have

$$dw/dt = kyz - dx/dt \quad \text{and} \quad dx/dt = k'w,$$

with the condition that initially $w = 0$. At first, then, $dx/dt = 0$.

If k' is large compared with k , we should have after a certain time

$$dw/dt = 0 \quad \text{and} \quad dx/dt = kyz,$$

so that after a certain time the action would go on as a bi-molecular action. But up to this time the velocity of the action would increase from 0 to a maximum value. In other words, we should have a period of induction. The duration of this period of induction will evidently depend on the quantities k and k' . If k' were large

* This view receives some support from the phenomena connected with the decomposition of organic compounds, alone, and in the presence of nitrogen, by means of the silent discharge. The compounds produced frequently contain more carbon atoms in the molecule than in the initial substances, and can be explained on the assumption of the breakdown of additive molecules. See BERTHELOT, 'Comptes Rendus,' 1898. The decomposition products of saturated hydrocarbons are also explainable in this way, e.g., acetylene is produced on heating methane.

compared with k , the period of induction would be correspondingly short. In other words, the duration of the induction period will depend on the stability of the intermediate compound.

If, then, there is an intermediate compound formed, a period of induction is to be expected. This phenomenon is observed in many cases, and especially in those which require for their finite velocity the presence of a catalyser. For example, the hydrogen and chlorine action. The action of bromine on fatty acids.* The reduction of metallic oxides by hydrogen and carbon monoxide.† In these actions the evidence for the period of induction is complete, and it cannot be regarded as due to disturbances arising from secondary causes unconnected with the action. Secondary causes may produce acceleration or retardation of an action, but the period of induction proper must be regarded as a characteristic of the action itself. This is in opposition to the view of VAN 'T HOFF. He says: "An acceleration of this kind is incompatible with the principles laid down in this book" ('Studies in Chemical Dynamics'), and he goes on to examine certain actions, and concludes that the accelerations observed are to be explained by secondary reactions. The reactions, he considers, are the change of rhombic into monoclinic sulphur, the formation of water from hydrogen and oxygen, and the polymerization of cyanic acid. The first and third of these actions are probably simple combinations, so that no acceleration would be expected other than that due to the action of the monoclinic sulphur in the one case and the cyamelide in the other. In the case of the formation of water the experimental evidence is not sufficient to justify the conclusion that there is no period of induction, for this period may be short and its effect observable only in the very early stages of the action, which for this particular action have not been observed. The very definite and constant character of the induction period in the hydrogen and chlorine action, which is one of the few actions whose early stages can be observed accurately, is sufficient evidence of the essential character of this period, and we cannot agree with VAN 'T HOFF in his conclusion that the existence of the induction period is merely "an indication that some necessary precaution has been omitted."‡

We come now to consider in more detail the hydrogen and chlorine action. The rate of progress of this action depends largely on the presence of water vapour. The drier the gases are the slower the action is, so that when the gases are dried with great care they do not combine completely after three or four days' exposure to bright sunlight. It seems, therefore, reasonable to suppose that under ordinary conditions the water vapour plays an essential part in the combination, and that without any water vapour present the action would not take place with measurable velocity. The fact that illumination of the chlorine alone before mixing with

* URECH, 'Berichte,' vol. 13, p. 539, 1880.

† WRIGHT, LUFF and RENNIE, 'Journal of Chem. Soc.,' 1879, p. 495.

‡ 'Studies in Chemical Dynamics,' p. 98.

hydrogen makes the action take place more readily, leads us to conclude that the first stage of the action is the formation of an additive compound from the chlorine and water vapour. Chlorine does form a hydrate with water, and the departure of chlorine from HENRY'S law, and other anomalous behaviour in solution, shows that it does tend to form additive molecules with water. We have seen that there is direct evidence for the existence of some new substance when light is allowed to fall on damp chlorine, but as yet we cannot say what this compound actually is. It is possible that a compound analogous to hydrogen peroxide is formed by simple addition of one molecule of water to one of chlorine.

The constitution of this compound would be represented by the following formula,

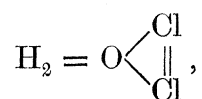

adopting to some extent NEF'S view of the action of an halogen in forming an additive compound. Such a compound might exist, but it would probably be extremely unstable, and would, if left to itself, break down into water and chlorine again, or into the molecules HCl and HClO. The fact that damp chlorine, under the influence of light, does yield these two compounds, supports to some extent this view. However, in the absence of direct evidence for the constitution of this compound, we shall simply assume that an additive molecule $(\text{H}_2\text{O})_{n_1} (\text{Cl}_2)_{n_2}$ is formed.

Illumination of the hydrogen alone, before mixing with chlorine, does not affect the rate of combination, so that there appears to be no direct additive compound of water and hydrogen formed. But on the present theory we suppose that the next stage in the action is the formation of a still more complex molecule, by the addition of one or more hydrogen molecules to the complex water-chlorine molecule. A molecule $(\text{H}_2\text{O})_{n_1} (\text{Cl}_2)_{n_2} (\text{H}_2)_{n_3}$ is thus formed. In this molecule the hydrogen and chlorine atoms can come into action with each other. A pair, consisting of a hydrogen atom and a chlorine atom, may nearly saturate each other, and, thus forming a system with little effect on the whole molecule, may split off from the complex molecule as a molecule of hydrochloric acid. The hydrochloric acid then finally produced is the result of the breakdown of the complex hydrogen-water-chlorine molecule. The rate of formation of hydrochloric acid is proportional to the concentration of the complex molecules $(\text{H}_2\text{O})_{n_1} (\text{Cl}_2)_{n_2} (\text{H}_2)_{n_3}$. The rate of formation of these is proportional to the concentration of the water-chlorine molecules and n_3^{th} power of the concentration of the hydrogen molecules. And the rate of formation of the water-chlorine molecules is proportional to the n_1^{th} power of the concentration of the water molecules, and the n_2^{th} power of the concentration of the chlorine molecules.

As at present we do not know the composition of the intermediate compounds, we shall work out the case when the complex molecule is as simple as it can be, that is when $n_1 = n_2 = n_3 = 1$.

When the combination takes place in a vessel under constant pressure and where the hydrochloric acid is absorbed as soon as it is made, the concentration of the H_2O , H_2 , and Cl_2 molecules can be considered to be constant, as the intermediate compounds are formed only in small quantities. If, however, as in GAUTIER and HÉLIER'S experiments, the action takes place in a closed vessel, the active masses of the hydrogen and chlorine diminish, and this must be taken into consideration. We shall assume that the water-vapour has constant concentration throughout, as it is liberated in the final stage of the action.*

Taking this second case first, let ξ be the number of chlorine or hydrogen molecules per unit volume (supposing the gases present in equivalent proportions). Let x be the number of molecules of the formula $\text{H}_2\text{O Cl}_2$, y the number of molecules H_2O , Cl_2 , H_2 , and $2z$ the number of molecules of hydrochloric acid. Then, from the law of mass action for the formation of the HCl molecules,

$$dz/dt = c_1 y,$$

c_1 being a constant dependent on the stability of the H_2O , Cl_2 , H_2 molecules ;

$$dy/dt = c_2 x \xi - dz/dt,$$

for the rate of formation of the H_2O , Cl_2 , H_2 molecules is proportional to the concentration of the H_2O , Cl_2 molecules and that of the H_2 molecules. And also for every two molecules of HCl formed, one molecule of H_2O , Cl_2 , H_2 is lost (we assume that the number of H_2 molecules is not appreciably different from the number of Cl_2 molecules, *i.e.*, that x can be neglected when compared with ξ).

And finally we have in a similar manner

$$dx/dt = c_3 \xi - c_2 x \xi.$$

And, since $2z$ is the number of HCl molecules formed, 2ξ the total number of H_2 and Cl_2 molecules, and there is no change in the total number of molecules (the number of intermediate molecules being negligible compared with those of hydrogen, chlorine, and hydrochloric acid),

$$\xi + z = \text{constant} = n.$$

For the case when the hydrochloric acid is absorbed as soon as it is produced, the concentration of the chlorine and hydrogen molecules remains constant and the equations are of the form,

$$\left. \begin{aligned} dz/dt &= c_1 y \\ dy/dt &= c_2 x - c_1 y \\ dx/dt &= c_3 - c_2 x \end{aligned} \right\} \dots \dots \dots (1),$$

* This assumption is perhaps not justifiable for some of GAUTIER and HÉLIER'S experiments, as the gases were partially dried, and so there was only a small quantity of water-vapour present.

when the steady state is reached ; dy/dt and dx/dt , both are zero, whence

$$dz/dt = c_3, \quad \bar{x} = \frac{c_3}{c_2}, \quad \bar{y} = \frac{c_3}{c_1},$$

where \bar{x} , \bar{y} are the final values of x and y .

Integrating equations (1) we obtain

$$\begin{aligned} x &= \frac{c_3}{c_2} (1 - e^{-c_2 t}), \\ y &= \frac{c_3}{c_1} \left(1 + \frac{c_2}{c_1 - c_2} e^{-c_1 t} \right) - \frac{c_3}{c_1 - c_2} e^{-c_2 t}, \\ z &= c_3 t - \frac{c_3}{c_1 - c_2} \left\{ \frac{c_1}{c_2} (1 - e^{-c_2 t}) - \frac{c_2}{c_1} (1 - e^{-c_1 t}) \right\}, \end{aligned}$$

using the condition that x , y , and z are initially zero.

For the velocity of formation of the hydrochloric acid we have

$$\frac{dz}{dt} = c_3 - \frac{c_3}{c_1 - c_2} (c_1 e^{-c_2 t} - c_2 e^{-c_1 t}),$$

and for the acceleration

$$\frac{d^2 z}{dt^2} = \frac{c_1 c_2 c_3}{c_1 - c_2} (e^{-c_2 t} - e^{-c_1 t}).$$

With regard to the constants c_1 , c_2 , c_3 ; c_3 is the final rate of formation of hydrochloric acid, and this was found to be proportional to the intensity of the light by BUNSEN and ROSCOE. c_3 is also a measure of the rate of formation of the chlorine-water additive molecules, and, as we have seen in the description of the cloud experiments on p. 106, the more intense the light the more rapid is the formation of the cloud producing nuclei. For the other two constants we have seen that the water-chlorine molecules are produced some time before any hydrochloric acid is formed, so that the last two stages of the action do not take place so rapidly that the first intermediate compound has a very short existence. Both c_1 and c_2 are, therefore, not very large. Further, BUNSEN and ROSCOE showed that there was a definite absorption of light associated with the combination—more than was absorbed by an equal quantity of damp chlorine. One, therefore, or both of the constants c_1 , c_2 depends on the light intensity. This also appears from the fact that the effect of insolation persists for some time after the mixture is darkened. If c_1 and c_2 were both independent of the intensity of the light, we should expect that in a short time the H_2O , Cl_2 molecules would all be used up, and that the gas would very soon return to its normal condition. But the effect of previous insolation can persist for several hours. This is explained if we suppose that the H_2O , Cl_2 molecules are able

to exist for some time, and are not liable to rapid spontaneous decomposition into the original molecules H_2O and Cl_2 , or into new molecules HCl and HClO . That this complex molecule is to some extent stable appears both from the expansion experiments in damp chlorine, and from the fact that pre-insolation of damp chlorine alone makes the subsequent combination with hydrogen more rapid (p. 101), for in these last experiments the chlorine was darkened while hydrogen was admitted, and this operation lasted sometimes for several minutes. Owing, however, to the difficulty of obtaining comparable results with these experiments, all that can be said is that the H_2O , Cl_2 molecules can exist at any rate for several minutes. The constants c_1 , c_2 cannot at present be more accurately defined, but we may suppose them both to depend on the intensity of the light.

The value for dz/dt ,

$$c_3 - \frac{c_3}{c_1 - c_2} (c_1 e^{-c_2 t} - c_2 e^{-c_1 t}),$$

represents the general features of the acceleration period. Originally dz/dt is zero, and also d^2z/dt^2 and higher coefficients. d^2z/dt^2 is always positive, and increases to a maximum at a time given by

$$\frac{e^{c_1 t}}{c_1} = \frac{e^{c_2 t}}{c_2}.$$

After this time d^2z/dt^2 decreases until dz/dt is constant.

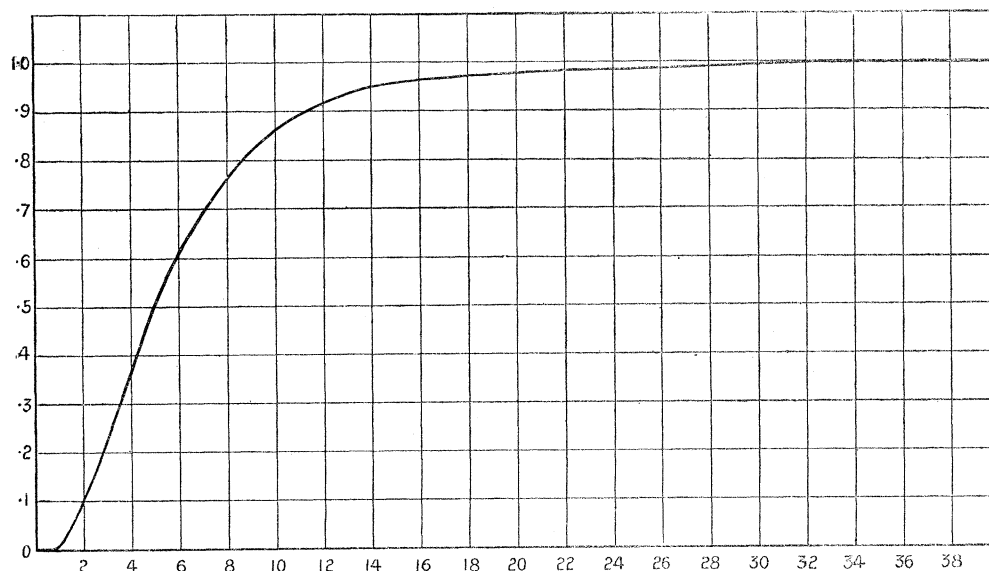

Fig. 18.

In fig. 18 the curve representing $1 - e^{-c_2 t} - \frac{c_2}{c_1} (1 - e^{-c_1 t})$ is plotted for the value $c_2/c_1 = .9$. This expression is proportional to dz/dt , and so the curve in the figure should represent the velocity curve of the reaction. The essential features are the

same, we have a period of inertness, a period of acceleration, and, finally, the constant value for the velocity, as we have in the experimental curves.

The main features of the induction period are therefore given by the formula we have obtained. If we make the more general assumption with regard to the intermediate compounds, we should considerably complicate the results, but it is easy to see that the inert period and acceleration period would be represented; but as at present we do not know what these compounds are, it is not worth while working out any more detailed results. We can at present only regard the expressions found above as giving the qualitative nature of the reaction, for we have omitted various possibilities of which account must be taken for a more exact theory. For example, we have neglected to take account of spontaneous decomposition of the intermediate products. We know that the water-chlorine molecule decomposes or is absorbed by the solution. We should have, therefore, in the equation for the rate of formation of this body another term, say Cx , so that the equation would become

$$dx/dt = c_3 - (c_2 + C)x,$$

where C is a constant, independent of the light intensity.

If then the light intensity be very small, c_3 would be small compared with C , and so x will increase exceedingly slowly, so that the apparently inert period may be prolonged to a very large extent. In any case, more terms in the equations of this type indicate prolongation of the period of induction, and especially the early part of this period.

With regard to the action of impurities, we can explain the phenomena if we assume that an action can take place between the impurity and the intermediate compounds. In this way a relatively small quantity of impurity would produce a large effect on the final rate of action, since the quantity of the intermediate products is always small.

If now we again consider the equations on p. 116 for the action when the hydrochloric acid is not absorbed, we notice that after the induction period is over, the action settles down to that represented approximately by the monomolecular equation

$$dz/dt = c_3\xi.$$

But here again the effect of spontaneous decomposition will be to change the character of the action. Assuming as before that the chlorine-water molecule spontaneously decomposes, we have, after the period of induction for the rate of formation of hydrochloric acid,

$$\frac{dz}{dt} = \frac{c_2c_3\xi^2}{c_1(C + c_2\xi)}.$$

If C be large compared with $c_2\xi$, then the action is approximately bi-molecular.

These considerations show that for such an action as we are considering, we cannot

assume that the normal course is of the ordinary mono-, bi-, or polymolecular type. By varying the conditions of the action, the relative values of the constants are changed, and the result may not agree with any of those deduced from the simple types of equation.

The hypothesis of the existence of intermediate compounds, formed with the water-vapour present in the gas mixture, leads us to equations which represent the phenomena observed, at any rate qualitatively. The catalytic action of the water-vapour in this case is due to its taking an essential part in the process of combination. The action is therefore on this theory more than a mere quickening of the action which would go on slowly without the catalyser. It is possible that the action takes place very slowly in dry gases, but it seems probable that, if so, it occurs in a different way, as for example, by the direct combination of dissociated atoms. The function of the water-vapour we have assumed to be to form a centre about which the hydrogen and chlorine molecules can assemble, so that the atoms come into each other's spheres of action and can re-arrange themselves, giving rise to a system of greater stability. This process we have supposed to take place by the formation of molecular compounds, and we have seen that a great many of the facts are explained on this hypothesis. We can regard this catalytic action as not essentially different from the catalytic action of such substances as platinum black. In these cases the gases in the action, helped by such a catalyser, probably form condensed layers on the catalyser, and thus the actual molecules of the combining gases are brought into very intimate contact, and re-arrangement of the atoms may take place.

In the particular case of the hydrogen and chlorine action, we have evidence of an unstable water-chlorine molecule, or, at any rate, aggregate, formed at the expense of the energy of the light, and it seems probable that in the case of other actions conditioned by the presence of water-vapour, the action proceeds by the aid of similar intermediate compounds. If this be so, we have seen how the action may not proceed in the way indicated by the ordinary theory, and so we have an explanation of the many anomalous results obtained in experiments on the rate of combination in gaseous systems.

SUMMARY.

I. *Experimental.*

- (1.) The initial expansion is the result of heat developed in the combination of hydrogen and chlorine.
- (2.) The initial expansion is an effect different from that observed when chlorine alone is acted on by light. This last effect is due to a rise in temperature, the energy for which is supplied by the light.
- (3.) The action ceases almost instantaneously when the light is cut off.

(4.) The combination is made very much more rapid by the presence of water-vapour.

(5.) Small quantities of impurities produce a great decrease in the rate of action.

(6.) The induction period may be prolonged indefinitely, but its general character remains the same.

(7.) Previous illumination of chlorine, before mixing with hydrogen, makes the action, when light falls on the mixture, faster to begin with—shortens the induction period. This property of insolated chlorine is lost if the chlorine be bubbled through water. Previous illumination of the hydrogen is without effect.

(8.) Before any hydrochloric acid is formed, some intermediate body is produced which can act as nucleus, on which a cloud can form on a certain expansion.

II. *Theoretical.*

(1.) The induction period is an essential part of the action, and occurs owing to the formation of intermediate compounds from water-vapour and the two gases. The nature of these compounds is not discovered; but it seems probable that, first,

an additive compound of chlorine and water is formed $\left(\text{perhaps } \text{H}_2 = \text{O} \begin{array}{c} \diagup \text{Cl} \\ \parallel \\ \diagdown \text{Cl} \end{array}\right),$

then a hydrogen molecule becomes attached to this, forming the compound

$\text{H}_2\text{O} \begin{array}{c} \diagup \text{Cl} \\ \parallel \\ \diagdown \text{Cl} \end{array} \text{H}_2,$ and finally this complex body breaks down into H_2O and 2HCl .

(2.) This view of the process of the combination explains the phenomena of the period of induction and the effect of pre-insolation of the chlorine, and makes it possible to understand the great effect of impurities.

(3.) This view of the action of water molecules, in forming additive compounds, can be extended to all those actions where water-vapour, as a catalyser, seems to be necessary for the progress of the action with finite velocity.

(4.) In the case of actions in gaseous systems, conditioned by the presence of a catalyser, a period of induction must be expected to occur, and the application of the law of mass action to such cases must be made with reference to the intermediate compounds formed. There is, therefore, no reason to expect that agreement will be found between the theory of mass action as applied to the end product equation and the actual experimental results.

In conclusion, I wish to express my thanks to Professor J. J. THOMSON for having suggested this investigation, and for his advice during the course of the experiments, which were performed at the Cavendish Laboratory.